

ENROUTE[®]
TRANSCAROTID STENT SYSTEM

INSTRUCTIONS FOR USE

SILKROAD[®]
MEDICAL[®]

The symbols glossary is provided in this IFU on page 4.

Instructions for Use
Silk Road Medical ENROUTE® Transcarotid Stent System

READ ALL INSTRUCTIONS CAREFULLY. Failure to properly follow the instructions, warnings and precautions may lead to serious consequences or injury to the patient.

ONLY PHYSICIANS WHO HAVE RECEIVED APPROPRIATE TRAINING FOR TRANSCAROTID STENTING AND WHO ARE FAMILIAR WITH THE PRINCIPLES, CLINICAL APPLICATIONS, COMPLICATIONS, SIDE EFFECTS AND HAZARDS COMMONLY ASSOCIATED WITH CAROTID INTERVENTIONAL PROCEDURES SHOULD USE THIS DEVICE.
Use only with ENROUTE Transcarotid Neuroprotection System (NPS).

EO STERILE. ENROUTE Transcarotid Stent System is sterilized with ethylene oxide (EO) gas.

Non-pyrogenic.

DO NOT USE THIS PRODUCT WITH POWER INJECTION SYSTEMS.

DO NOT RE-USE.

















DO NOT RESTERILIZE.

DO NOT USE THIS PRODUCT PAST ITS EXPIRATION DATE.

THIS PRODUCT IS RADIOPAQUE.

STORE IN A COOL, DARK, DRY PLACE.

Definitions of Symbols

Symbol	Title/Description	Standard and reference number
	Caution	ISO 15223-1:2016 5.4.4
	Consult Instructions for Use	ISO 15223-1:2016 5.4.3
	Sterilized using Ethylene Oxide	ISO 15223-1:2016 5.2.3
	Caution: Federal (US) law restricts this device to sale by or on the order of a physician	N/A
	Lot Number	ISO 15223-1:2016 5.1.5
	Manufacturer	ISO 15223-1:2016 5.1.1
	Do not use if package is damaged	ISO 15223-1:2016 5.2.8
	Keep dry.	ISO 15223-1:2016 5.3.4
	Keep away from sunlight	ISO 15223-1:2016 5.3.2
	Use by Date	ISO 15223-1:2016 5.1.4
	Catalog Number	ISO 15223-1:2016 5.1.6
	Do Not Reuse	ISO 15223-1:2016 5.4.2
	Do Not Resterilize	ISO 15223-1:2016 5.2.6
	Non-pyrogenic	ISO 15223-1:2016 5.6.3
	n units per box	N/A
	Not made with natural rubber latex	ISO 15223-1:2016 5.4.5, Annex B B.2
	MR Conditional	ASTM F2503-20 7.4.6

Instructions for Use, ENROUTE Transcarotid Stent System, Table of Contents

1.0	Device Name
2.0	Description
3.0	Indications for Use
4.0	Contraindications
5.0	Warnings
5.1	General Warnings
5.2	Patient Selection Warnings
5.3	Device Use Warnings
6.0	Precautions
6.1	Stent Handling Precautions
6.2	Stent Placement Precautions
6.3	Post Stent Placement Precautions
6.4	MRI Safety Information
7.0	Adverse Events
7.1	Observed Adverse Events – Clinical Studies
7.2	ROADSTER 2 Study – Post-Approval Study of Transcarotid Artery Revascularization in Patients with Significant Carotid Artery Disease
7.3	ROADSTER Study – Sub-Study of Patients Treated with a Combination of the PRECISE Stent System and the ENROUTE Transcarotid Neuroprotection System
7.4	PROOF Pivotal Study – Sub-Study of Patients Treated with a Combination of the PRECISE Stent System and the ENROUTE Transcarotid Neuroprotection System
7.5	Potential Adverse Events
7.6	Device Related Adverse Event Reporting
8.0	Clinical Study Information
8.1	The ROADSTER Study
8.2	The ROADSTER 2 Study
8.3	Propensity Score Matched Analysis of Patients Treated with Transcarotid Artery Revascularization (TCAR) and Carotid Endarterectomy (CEA) in Patients Deemed to be at Standard Risk for Adverse Events from CEA
9.0	Directions for Use
9.1	Peri-Procedural Care
9.2	Pre-Procedure
9.3	Device Selection and Preparation
9.4	Stent Deployment Procedure
10.0	Disclaimer of Warranty and Limitation of Remedy
11.0	License and Patent Disclosure

1.0 Device Name

The device brand name is the ENROUTE® Transcarotid Stent System.

2.0 Description

The ENROUTE Transcarotid Stent System consists of a nitinol self-expanding stent preloaded on a 5F (.065" / 1.65 mm) or 6F (.078" / 1.98 mm) sheathed delivery system. The rapid exchange delivery system consists mainly of an inner shaft and an outer sheath with radiopaque markers, and a Tuohy Borst valve. The inner shaft consists of a support member and wire lumen. The proximal portion of the support member is comprised of a hub connected to a stainless steel wire and hypotube and distally of a stainless steel coil. The wire lumen originates distally in a catheter tip and terminates proximally at a guidewire exit port designed to accept a .014" (0.36 mm) guidewire. The outer sheath has a proximal shaft and distal outer sheath with a nominal working length of 57 cm. The self-expanding ENROUTE Transcarotid Stent System is constrained within the space between the inner shaft and the distal outer sheath, located between distal and proximal stent markers on the inner shaft. The stent expands to its unconstrained diameter when released from the deployment catheter into the carotid artery. Upon deployment, the stent forms a lattice to cover the diseased arterial segment and pushes outward on the luminal surface, helping to maintain the patency of the artery. Due to the self-expanding behavior of nitinol, the stents are indicated for placement into vessels that are 1-2 mm smaller in diameter than the unconstrained diameter of the stent. Device depictions and components are provided in **Figure 1**.

Figure 1. ENROUTE TRANSCAROTID STENT SYSTEM

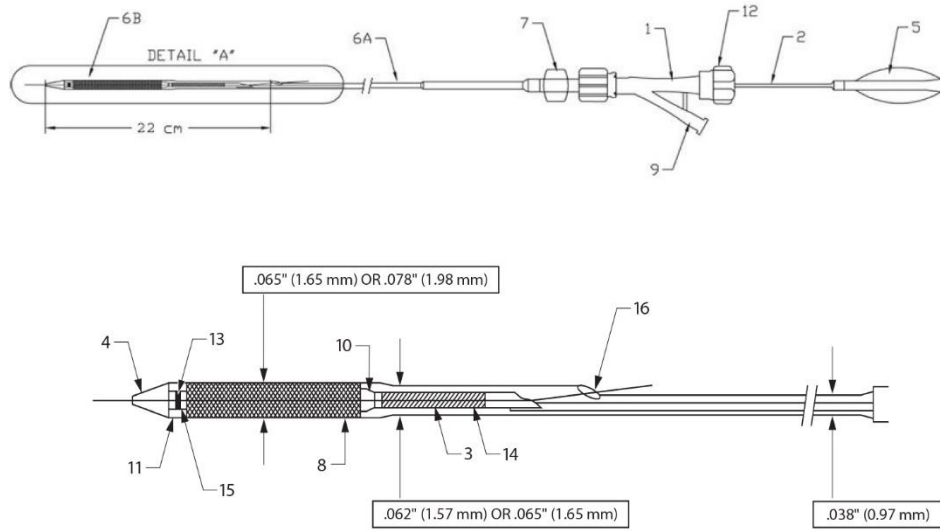

- 1. Tuohy Borst valve
- 2. Hypotube
- 3. Coil
- 4. Catheter Inner Shaft Tip
- 5. Inner Shaft Hub
- 6A. Proximal Shaft
- 6B. Distal Outer Sheath
- 7. Outer Sheath Luer Hub
- 8. Pod Housing Crimped Stent
- 9. Tuohy Borst Y-Connection
- 10. Proximal Inner Shaft Marker (Stop) Marks
- 11. Outer Sheath Radiopaque Marker
- 12. Proximal Valve End
- 13. Distal Inner Shaft Stent Marker
- 14. Coil Sleeve
- 15. Wire Lumen
- 16. Guidewire Exit Port

The ENROUTE Transcarotid Stent System is provided as noted in **Table 1** below.

Table 1
ENROUTE Transcarotid Stent System
57 cm Working Length
Guidewire Lumen: Accepts .014" (0.36 mm) Guidewire
For use with ENROUTE Transcarotid Arterial Sheath (8F ID, 2.7 mm)

.065" (1.65 mm) ENROUTE CODES	UNCONSTRAINED STENT DIMENSIONS Diameter x Length (mm)	CROSSING PROFILE
SR-0520-CS	5 x 20	5F (.078", 1.98 mm)
SR-0530-CS	5 x 30	5F (.078", 1.98 mm)
SR-0540-CS	5 x 40	5F (.078", 1.98 mm)
SR-0620-CS	6 x 20	5F (.078", 1.98 mm)
SR-0630-CS	6 x 30	5F (.078", 1.98 mm)
SR-0640-CS	6 x 40	5F (.078", 1.98 mm)
SR-0720-CS	7 x 20	5F (.078", 1.98 mm)
SR-0730-CS	7 x 30	5F (.078", 1.98 mm)
SR-0740-CS	7 x 40	5F (.078", 1.98 mm)
SR-0820-CS	8 x 20	5F (.078", 1.98 mm)
SR-0830-CS	8 x 30	5F (.078", 1.98 mm)
SR-0840-CS	8 x 40	5F (.078", 1.98 mm)
SR-0920-CS	9 x 20	6F (.087", 2.21 mm)
SR-0930-CS	9 x 30	6F (.087", 2.21 mm)
SR-0940-CS	9 x 40	6F (.087", 2.21 mm)
SR-1020-CS	10 x 20	6F (.087", 2.21 mm)
SR-1030-CS	10 x 30	6F (.087", 2.21 mm)
SR-1040-CS	10 x 40	6F (.087", 2.21 mm)

3.0 Indications for Use

The ENROUTE Transcarotid Stent System used in conjunction with the ENROUTE Transcarotid Neuroprotection System (NPS) is indicated for the treatment of patients at high risk and standard risk for adverse events from carotid endarterectomy, who require carotid revascularization and meet the criteria outlined below:

	High Risk	Standard Risk
With neurological symptoms	≥ 50% stenosis of the common or internal carotid artery by ultrasound or angiogram	≥ 70% stenosis of the common or internal carotid artery by ultrasound or ≥ 50% stenosis of the common or internal carotid artery by angiogram
Without neurological symptoms	≥ 80% stenosis of the common or internal carotid artery by ultrasound or angiogram	≥ 70% stenosis of the common or internal carotid artery by ultrasound or ≥ 60% stenosis of the common or internal carotid artery by angiogram
Reference vessel diameter	Must be within 4.0 mm – 9.0 mm at the target lesion	
Carotid bifurcation location	Minimum 5 cm above the clavicle to allow for placement of the ENROUTE Transcarotid NPS	

4.0 Contraindications

Use of the ENROUTE Transcarotid Stent System is contraindicated in the following patients:

1. Patients in whom antiplatelet and/or anticoagulation therapy is contraindicated.
2. Patients in whom the ENROUTE Transcarotid NPS is unable to be placed.
3. Patients with uncorrected bleeding disorders.
4. Patients with known allergies to nitinol.
5. Lesions in the ostium of the common carotid artery.

5.0 Warnings

5.1 General Warnings

1. Only physicians who have received appropriate training for transcarotid stenting and who are familiar with the principles, clinical applications, complications, side effects and hazards commonly associated with carotid interventional procedures should use this device.
2. The safety and efficacy of the ENROUTE Transcarotid Stent System have not been demonstrated with embolic protection systems other than the ENROUTE Transcarotid NPS. Use the ENROUTE Transcarotid Stent System only with the ENROUTE Transcarotid NPS.
3. The long term performance (> 3 years) of carotid stents has not yet been established.
4. As with any type of vascular implant, infection secondary to contamination of the stent may lead to thrombosis, pseudoaneurysm or rupture.
5. The stent may cause a thrombus, distal embolization or may migrate from the site of implant through the arterial lumen. Appropriate sizing of the stent to the vessel is required to reduce the possibility of stent migration (see Section 9.3 of these instructions). In the event of thrombosis of the expanded stent, thrombolysis and PTA should be attempted.
6. Overstretching of the artery may result in rupture and life-threatening bleeding.
7. In patients requiring the use of antacids and/or H2-antagonists before or immediately after stent placement, oral absorption of antiplatelet agents (e.g. aspirin) may be adversely affected.
8. The appropriate antiplatelet and anticoagulation therapy should be administered pre- and post-procedure as suggested in Section 9.1 of these instructions.
9. In the event of complications such as infection, pseudoaneurysm or fistulization, surgical removal of the stent may be required.

5.2 Patient Selection Warnings

1. Safety and effectiveness of the ENROUTE Transcarotid Stent System has **NOT** yet been established in patients with the characteristics noted below.

Lesion Characteristics:

- Patients with evidence of intraluminal thrombus thought to increase the risk of plaque fragmentation and distal embolization.
- Patients whose lesion(s) may require more than two stents.
- Patients with total occlusion of the target vessel.
- Patients with lesions of the ostium of the common carotid.
- Patients with highly calcified lesions resistant to PTA.
- Concurrent treatment of bilateral lesions.

Patient Characteristics:

- Patients at low-to-moderate risk for adverse events from carotid endarterectomy.
- Patients experiencing acute ischemic neurologic stroke or who experienced a stroke within 48 hours.
- Patient has had a recent (<7 days) stroke of sufficient size (on CT or MRI) to place him or her at risk of hemorrhagic conversion during the procedure.
- Patients with ipsilateral intracranial or extracranial arterial stenosis greater in severity than the lesion to be treated, cerebral aneurysm > 5 mm, AVM (arteriovenous malformation) of the cerebral vasculature, or intracranial tumor.
- Patients with arterio-venous malformations in the territory of the target carotid artery.
- Patients with bleeding diathesis or coagulopathies.
- Patients with poor renal function, who, in the physician's opinion, may be at high risk for a reaction to contrast medium.
- Patients with perforated vessels evidenced by extravasation of contrast media.
- Patients with aneurismal dilation immediately proximal or distal to the lesion.
- Pregnant patients or patients under the age of 18.

Access Characteristics:

- Patients with known internal carotid artery tortuosity that would preclude the use of catheter-based techniques.
- Patients with known common carotid or internal carotid artery tortuosity that would preclude the use of catheter-based techniques.
- Patients in whom common carotid access is not possible.

2. Risk of distal embolization may be higher if the ENROUTE Transcarotid Stent System cannot be used in conjunction with the ENROUTE Transcarotid NPS during the carotid stenting procedure.

5.3 Device Use Warnings

1. USE OF A SMALLER THAN INDICATED ACCESSORY DEVICE OTHER THAN THE ENROUTE TRANSCAROTID ARTERIAL SHEATH MAY LEAD TO INTRODUCTION OF AIR INTO THAT DEVICE AS THE STENT DELIVERY SYSTEM IS ADVANCED, WHICH MAY NOT BE REMOVED DURING AIR ASPIRATION.

2. Ensure that the catheter system is flushed according to the steps outlined in "Introduction of Stent Delivery System" (**Section 9.4**). Failure to do so could result in air entering the ENROUTE's Transcarotid Arterial Sheath.

3. Ensure that there is a tight seal between the ENROUTE catheter and the valve for the ENROUTE Transcarotid Arterial Sheath during aspiration. Failure to do so could result in air entering the ENROUTE Transcarotid Arterial Sheath.

4. The black dotted pattern on the gray temperature exposure indicator found on the pouch must be clearly visible.

DO NOT USE THE PRODUCT IF THE ENTIRE TEMPERATURE EXPOSURE INDICATOR IS COMPLETELY BLACK as the pre-programmed stent diameter may have been compromised.

5. Do not use the device if there are abnormalities in the sterile barrier (e.g. broken seal, torn or breached barrier) or the product.

6. This device is intended for one-time use only. Do not re-sterilize and/or reuse. Structural integrity and/or function may be impaired through reuse or cleaning.

7. Do not use the ENROUTE Transcarotid Stent System after the "Use By" date specified on the package.
8. Do not use with Ethiodol or Lipiodol* contrast media, which may adversely affect the stent delivery system.
*Ethiodol and Lipiodol are Trademarks of Guerbet S.A.
9. Do not expose the delivery system to organic solvents (e.g., alcohol) as structural integrity and/or function of the device may be impaired.
10. The stent is not designed for dragging or repositioning.
11. Once the stent is partially deployed, it cannot be recaptured using the stent delivery system.
12. As with any type of vascular implant, infection secondary to contamination of the stent may lead to thrombosis, pseudoaneurysm or rupture.
13. When multiple stents are used, they should be of similar composition.
14. Long-term outcomes following repeat dilatation of endothelialized stents are unknown.

6.0 Precautions

6.1 Stent Handling Precautions

1. The ENROUTE Transcarotid Stent System is supplied **STERILE** and is intended for single use only. DO NOT resterilize and/or reuse the device.
2. The ENROUTE Transcarotid Stent System is shipped with the Tuohy Borst valve in the **OPEN** position. Care should be taken not to pre-deploy the stent. The device should be prepped in the tray. (See **Section 9.3** of these instructions).
3. Do not use the ENROUTE Transcarotid Stent System after the "Use By" date specified on the package.
4. Do not use if the pouch is opened or damaged.
5. Store in a cool, dark, dry place.

6.2 Stent Placement Precautions

1. Venous access should be available during carotid stenting in order to manage bradycardia and/or hypotension either by pharmaceutical intervention or placement of a temporary pacemaker, if needed.
2. When catheters are in the body, they should be manipulated only under fluoroscopy. Radiographic equipment that provides high quality images is needed.
3. The delivery system is not designed for the use of power injection. Use of power injection may adversely affect device performance.
4. If resistance is met during delivery system introduction, the system should be withdrawn and another system used.
5. Prior to stent deployment, remove all slack from the catheter delivery system (see **Section 9.4, 4** of these instructions).
6. Adequate distance must be maintained from the distal tip of the transcarotid access sheath and the proximal edge of the stent to avoid stent delivery within the lumen of the sheath.
7. When treating multiple lesions, the distal lesion should be initially stented, followed by stenting of the proximal lesion. Stenting in this order obviates the need to cross the proximal stent in placement of the distal stent and reduces the chance for dislodging stents that have already been placed.
8. Overlap of sequential stents is necessary, but the amount of overlap should be kept to a minimum (approximately 5 mm). In no instance should more than 2 stents overlap.
9. Fractures of this stent may occur. Fractures may also occur with the use of multiple overlapping stents. Fractures have been reported most often in clinical uses for which the safety and effectiveness have not been established. The causes and clinical implications of stent fractures are not well characterized. Care should also be taken when deploying the stent as excessive force could, in rare instances, lead to stent deformation and/or fracture.

6.3 Post Stent Placement Precautions

1. Recrossing a deployed stent with adjunct devices must be performed with caution.
2. In the event of thrombosis of the expanded stent, thrombolysis and PTA should be attempted.

6.4 MRI Safety Information

MRI Safety Information	
 MR Conditional	<p>The ENROUTE Transcarotid Stent in single and overlapped versions at lengths up to and including 75-mm is MR Conditional. A patient with the ENROUTE Transcarotid Stent may be safely scanned under the following conditions. Failure to follow these conditions may result in injury to the patient.</p>
Parameter	Condition
Nominal Values of Static Magnetic Field (T)	1.5-T and 3.0-T
Maximum Spatial Field Gradient (T/m and gauss/cm)	20-T/m (2,000-gauss/cm)
Type of RF Excitation	Circularly Polarized (CP) (i.e., quadrature-driven)
Transmit RF Coil Information	There are no transmit RF coil restrictions. Accordingly, the following may be used: body transmit RF coil and all other RF coil combinations (i.e., body RF coil combined with any receive-only RF coil, transmit/receive head RF coil, transmit/receive knee RF coil, etc.)
Operating Mode of MR System	Normal Operating Mode
Maximum Whole Body Averaged SAR	2-W/kg (Normal Operating Mode)
Limits on Scan Duration	Whole body averaged SAR of 2-W/kg for 60 minutes of continuous RF exposure (i.e., per pulse sequence or back to back sequences/series without breaks)
MR Image Artifact	The presence of this implant produces an imaging artifact. Therefore, carefully select pulse sequence parameters if the implant is located in the area of interest.

7.0 Adverse Events

The ENROUTE Transcarotid Stent System is a stenting platform based upon the FDA-approved Cordis PRECISE Nitinol Stent System (PRECISE). The ENROUTE Transcarotid Stent System is identical to the PRECISE Stent System with the exception of the working length of the delivery system. The ENROUTE Transcarotid Stent System has a working length of 57 cm whereas the PRECISE Stent System has a working length of 135 cm. The adverse event information presented herein encompasses clinical trial data on the use of the PRECISE Stent System in combination with the ENROUTE Transcarotid NPS (see Section 7.1, Observed Adverse Events). Additional adverse event information is derived from clinical trial data on the use of the PRECISE Stent System and the ANGIOGUARD® XP Emboli Capture Guidewire. These data are supplemented by the adverse event data from the ROADSTER 2 Post-Approval Study.

7.1 Observed Adverse Events – Clinical Studies

Carotid stenting with reverse flow proximal embolic protection using the PRECISE Stent System and the ENROUTE Transcarotid Neuroprotection System was conducted in 722 patients in the ROADSTER 2 study (per protocol: n = 632), the ROADSTER study (lead-in and pivotal: n=52, Continued Access: n=25) and the PROOF study (n=13). In the ROADSTER 2 study, the per protocol population totaling 632 patients who were at high risk for complications from carotid endarterectomy who require carotid revascularization were enrolled to evaluate real world usage of the

ENROUTE Transcarotid Stent when used with ENROUTE Transcarotid Neuroprotection System by physicians of varying levels of experience. In the ROADSTER study, a sub-study of 77 patients combined (lead-in and pivotal: n=52, Continued Access: n=25) who were at high risk for complications from carotid endarterectomy (CEA) were enrolled to evaluate the safety and effectiveness of the PRECISE Stent System when used with the ENROUTE Transcarotid Neuroprotection System. In the PROOF Study, 13 patients who were at standard and high risk for complications from CEA were enrolled to evaluate the feasibility of the carotid angioplasty and stenting with ENROUTE Transcarotid NPS. These data serve as the basis for the safety and effectiveness of the ENROUTE Transcarotid Stent System which differs from the PRECISE Stent System only in the working length of the delivery system. Safety and effectiveness data for the PRECISE Stent System when used with the ANGIOGUARD XP Emboli Capture Guidewire can be found on FDA’s website at the following URL:

http://www.accessdata.fda.gov/cdrh_docs/pdf3/P030047b.pdf. 510(k) clearance of the ENROUTE Transcarotid NPS was supported by data from the full cohort of patients enrolled in the ROADSTER study (n=141) when used with any FDA-approved carotid stent system.

The Major Adverse Event rate in the combined ROADSTER sub-study population (subjects treated with a combination of the PRECISE Stent and the ENROUTE Transcarotid NPS) was 3.9%. Two subjects experienced a minor ipsilateral stroke and one patient experienced a myocardial infarction within the 30-day follow-up period.

7.2 ROADSTER 2 Study – Post-Approval Study of Transcarotid Artery Revascularization in Patients with Significant Carotid Artery Disease

This prospective, single arm, multi-center study included 632 subjects in the per protocol population and 692 subjects in the ITT population at high risk for complications from CEA. The ENROUTE Transcarotid Stent System was used in conjunction with the ENROUTE Neuroprotection system. The major adverse event (MAE) rate was defined as death, stroke, or MI to 30 days. The 30-day MAE rate for these patients was 1.7% and 3.2% for the PP and ITT populations, respectively.

Table 2a
Major Adverse Events to 30 Days – PP and ITT Populations

Parameters and Statistics	Per-Protocol Population (N=632)	Intention to Treat Population (N=692)
Number of Patients Who Experienced an MAE		
N (%)	11 (1.7%)	22 (3.2%)
95% Exact Binomial Confidence Intervals	(0.87, 3.09)	(2.00, 4.77)
p-value	0.0000	0.0000
Number of Patients Who Died Within 30 Days of the Index Procedure		
N (%)	1 (0.2%)	3 (0.4%)
Number of Patients Who had a Stroke Within 30 Days of the Index Procedure		
N (%)	4 (0.6%)	13 (1.9%)
Number of Patients Who had an MI Within 30 Days of the Index Procedure		
N (%)	6 (0.9%)	6 (0.9%)

7.3 ROADSTER Pre-Approval Study – Sub-Study of Patients Treated with a Combination of the PRECISE Stent System and the ENROUTE Transcarotid Neuroprotection System

This prospective, single arm, multi-center study included 77 patients (lead-in and pivotal: n=52, Continued Access: n=25) at high risk for complications from CEA. The PRECISE Stent System was used as a surrogate for the ENROUTE Transcarotid Stent System as the two systems differ only in the working length. The major adverse event (MAE) rate was defined as death, stroke, or MI to 30 days. The 30-day MAE rate for these patients was 3.9%. Serious adverse events to 30 days from the ROADSTER sub-study are presented in Table 2b for the Intent to Treat (ITT) population and Table 2c for the Per Protocol (PP) population:

Table 2b

Serious Adverse Events to 30 Days (ITT)

System Organ Class Preferred Term	All PRECISE Stent Subjects in ROADSTER Lead-in and Pivotal (n=52)	All PRECISE Stent Subjects in ROADSTER Continued Access Population (n=25)	All PRECISE Stent Subjects in ROADSTER Combined Population (n=77)
Number (%) of Subjects with one or more Serious Adverse Events	7 (13.5%)	2 (8.0%)	9 (11.7%)
Blood And Lymphatic System Disorders	1 (1.9%)	0 (0.0%)	1 (1.3%)
Anaemia	1 (1.9%)	0 (0.0%)	1 (1.3%)
Cardiac Disorders	1 (1.9%)	2 (8.0%)	3 (3.9%)
Cardiac arrest	0 (0.0%)	1 (4.0%)	1 (1.3%)
Cardiac Failure Congestive	1 (1.9%)	0 (0.0%)	1 (1.3%)
Myocardial Infarction	0 (0.0%)	1 (4.0%)	1 (1.3%)
Injury, Poisoning And Procedural Complications	1 (1.9%)	0 (0.0%)	1 (1.3%)
Post Procedural Hemorrhage	1 (1.9%)	0 (0.0%)	1 (1.3%)
Nervous System Disorders	1 (1.9%)	1 (4.0%)	2 (2.6%)
Cerebrovascular Accident	1 (1.9%)	0 (0.0%)	1 (1.3%)
Ischemic Stroke	0 (0.0%)	1 (4.0%)	1 (1.3%)
Respiratory, Thoracic And Mediastinal Disorders	1 (1.9%)	0 (0.0%)	1 (1.3%)
Atelectasis	1 (1.9%)	0 (0.0%)	1 (1.3%)
Vascular Disorders	2 (3.8%)	0 (0.0%)	2 (2.6%)
Artery Dissection	1 (1.9%)	0 (0.0%)	1 (1.3%)
Hypotension	1 (1.9%)	0 (0.0%)	1 (1.3%)

**Table 2c
Serious Adverse Events to 30 Days (PP)**

System Organ Class Preferred Term	All PRECISE Stent Subjects in ROADSTER Lead-in and Pivotal (n=48)	All PRECISE Stent Subjects in ROADSTER Continued Access Population (n=20)	All PRECISE Stent Subjects in ROADSTER Combined (n=68)
Number (%) of Subjects with one or more Serious Adverse Events	6 (12.5%)	0 (0.0%)	6 (8.8%)
Blood And Lymphatic System Disorders	1 (2.1%)	0 (0.0%)	1 (1.5%)
Anaemia	1 (2.1%)	0 (0.0%)	1 (1.5%)
Cardiac Disorders	1 (2.1%)	0 (0.0%)	1 (1.5%)
Cardiac Failure Congestive	1 (2.1%)	0 (0.0%)	1 (1.5%)
Injury, Poisoning And Procedural Complications	1 (2.1%)	0 (0.0%)	1 (1.5%)
Post Procedural Hemorrhage	1 (2.1%)	0 (0.0%)	1 (1.5%)
Respiratory, Thoracic And Mediastinal Disorders	1 (2.1%)	0 (0.0%)	1 (1.5%)
Atelectasis	1 (2.1%)	0 (0.0%)	1 (1.5%)
Vascular Disorders	2 (4.2%)	0 (0.0%)	2 (2.9%)
Artery Dissection	1 (2.1%)	0 (0.0%)	1 (1.5%)
Hypotension	1 (2.1%)	0 (0.0%)	1 (1.5%)

Results from the ROADSTER sub-study of subjects receiving the PRECISE stent (n=77; 3.9%) were comparable to results seen in the ROADSTER ITT Population (pivotal and Continued Access study cohort, combined) (n=219; 3.7%).

ROADSTER 2 collected only treatment-emergent adverse events which are tabulated in Table 4 below.

7.4 PROOF Pre-Approval Pivotal Study – Sub-Study of Patients Treated with a Combination of the PRECISE Stent System and the ENROUTE Transcarotid Neuroprotection System

This prospective, single arm, multi-center study included 13 patients at standard and high risk for complications from CEA. The PRECISE Stent System was used as a surrogate for the ENROUTE Transcarotid Stent System as the two systems differ only in the working length. The major adverse event (MAE) rate was defined as death, major

stroke, or MI to 30 days. It should be noted that, although the primary endpoint for stroke included only major stroke, there were no minor strokes in this sub-study population. The 30-day MAE rate for these patients was 0.0%. Serious adverse events to 30 days from the PROOF sub-study are presented in the following table:

Table 3
ENROUTE Transcarotid Stent System
Serious Adverse Events

System Organ Class	All PRECISE Stent Subjects in PROOF (N=13)
Number (%) of Subjects with one or more Serious Adverse Events	13 (100%)
Cardiac Disorders	2 (15.4%)
Gastrointestinal Disorders	2 (15.4%)
General Disorders and Administration Site Conditions	1 (7.7%)
Infections and Infestations	1 (7.7%)
Investigations	2 (15.4%)
Nervous System Disorders	7 (53.8%)
Respiratory, Thoracic, and Mediastinal Disorders	1 (7.7%)
Skin and Subcutaneous Tissue Disorders	2 (15.4%)
Surgical and Medical Procedures	1 (7.7%)
Vascular Disorders	7 (53.8%)

7.4 ROADSTER 2 Post-Approval Study

In the Per Protocol cohort of ROADSTER 2, there were 27 adverse events. The Major Adverse Events included one (1) death (0.2%), four (4) strokes (0.6%) and six (6) myocardial infarctions (0.9%). These are separately tabulated in Table 2a above. There were seven (7) arterial dissections (1.1%). Two (2) arterial dissections were converted to CEA (0.3%). The remaining event was stent thrombosis (0.2%). None of the adverse events led to study discontinuation.

Table 4
Summary of Adverse Events by Event Type – Per Protocol and ITT Populations

Parameters and Statistics	Per Protocol Population (N=632)	Intention to Treat Population (N=692)
Incidence of Unique Adverse Events	27 (4.3%)	45 (6.5%)
Cranial Nerve Injury	8 (1.3%)	10 (1.4%)
Death - Neurological	0 (0%)	2 (0.3%)
Death - Other	1 (0.2%)	1 (0.1%)
Myocardial infarction	6 (0.9%)	7 (1.0%)
NPS device related event	2 (0.3%)	2 (0.3%)
Possibly NPS/Stent device related event	5 (0.8%)	7 (1.0%)
Stent device related event	1 (0.2%)	1 (0.1%)
Stroke, Contralateral	1 (0.2%)	1 (0.1%)
Stroke, Ipsilateral	3 (0.5%)	14 (2.0%)

7.5 Potential Adverse Events

Adverse Events (in alphabetical order) that may be associated with the use of the ENROUTE Transcarotid Stent System when used in conjunction with the ENROUTE Transcarotid NPS include, but may not be limited to (based upon clinical trial data for the PRECISE Stent System and the ANGIOGUARD XP Emboli Capture Guidewire and clinical trial data from the ROADSTER and PROOF studies):

- Air embolism
- Allergic/anaphylactoid reaction
- Anemia
- Aneurysm
- Angina/coronary ischemia
- Arrhythmia (including bradycardia, possibly requiring need for a temporary or permanent pacemaker)

- Arterial dissection
- Arterial occlusion/restenosis of the treated vessel
- Arterial occlusion/thrombus, at puncture site
- Arterial occlusion/thrombus, remote from puncture site
- Arteriovenous fistula
- Atelectasis
- Atrial fibrillation
- Bacteremia or septicemia
- Cerebral edema
- Congestive Heart Failure
- Death
- Embolization, arterial
- Embolization, stent
- Emergent repeat hospital intervention
- Fever
- Gastrointestinal disorders
- GI bleeding from anticoagulation/antiplatelet medication
- Hallucination
- Hematoma bleed, access site
- Hematoma bleed, remote site
- Hemorrhage
- Hyperperfusion syndrome
- Hypotension/hypertension
- Hypomagnesaemia
- Hypophosphatemia
- Infection
- Intimal injury/dissection
- Ischemia/infarction of tissue/organ
- Local infection and pain at insertion site
- Malposition (failure to deliver the stent to the intended site)
- Myocardial infarction
- Nausea
- Oxygen saturation decrease
- Pain
- Pseudoaneurysm
- Rales
- Renal failure
- Respiratory infection
- Restenosis of the vessel (> 50% obstruction)
- Rhinorrhea
- Seizure
- Severe unilateral headache
- Stent migration
- Stent thrombosis
- Stroke
- Transient ischemic attack
- Transient intolerance to reverse flow
- Urinary tract infection
- Vasospasm
- Venous occlusion/thrombosis, at puncture site
- Venous occlusion/thrombosis, remote from puncture site
- Vessel rupture, dissection, perforation
- Vomiting
- Wheezing

7.6 Device Related Adverse Event Reporting

Any adverse event (clinical incident) involving the ENROUTE Transcarotid Stent System should be reported to Silk Road Medical, Inc. immediately. To report an incident, call Silk Road Medical, Inc. at 408-720-9002.

8.0 Clinical Study Information

The ROADSTER clinical study was conducted to evaluate the safety and effectiveness of the PRECISE Stent System when used with the ENROUTE Transcarotid NPS. The PRECISE Stent System was used as a surrogate for the ENROUTE Transcarotid Stent System as the two systems differ only in the working length. The ROADSTER pivotal study data are presented below.

8.1 The ROADSTER Pre-Approval Study

The ROADSTER study was a prospective, single-arm, multi-center clinical trial of the ENROUTE Transcarotid NPS in conjunction with all FDA-approved carotid artery stents including the PRECISE Stent System used for revascularization in patients with carotid disease who were at high risk for complications from carotid endarterectomy (CEA). There was a lead-in phase of up to five (5) patients per investigator to allow investigators to gain experience with the study device prior to pivotal study enrollment. Sixty-seven (67) lead-in, one-hundred forty-one (141) pivotal and seventy-eight (78) Continued Access subjects at high risk for complications from CEA were enrolled between November 2012 and March 2016. A sub-study of 18 lead-in, 34 pivotal and 25 Continued Access subjects at high risk for complications from CEA and treated with the PRECISE Stent System was also conducted. The study included patients with atherosclerotic extracranial internal carotid stenosis (ICA) with or without involvement of the contiguous common artery (CCA) determined by duplex ultrasound, CT/CTA, MR/MRA or angiography. The study population consisted of male and female subjects at least 18 years of age meeting one of the following criteria regarding neurological symptom status and degree of stenosis:

Symptomatic: Stenosis must be >50% as determined by angiogram and the patient has a history of stroke (minor or non-disabling), TIA and/or amaurosis fugax within 180 days of the procedure, OR

Asymptomatic: Stenosis must be >70% as determined by angiogram without any neurological symptoms within the prior 180 days.

Eligible subjects were scheduled to undergo carotid revascularization any FDA-approved carotid artery stent system with the ENROUTE Transcarotid NPS. Subjects were followed for 30 days post-procedure. Patients met at least one of the surgical high-risk criteria listed below.

Anatomic High Risk Inclusion Criteria:

- A. Contralateral carotid artery occlusion
- B. Tandem stenoses >70%
- C. High cervical carotid artery stenosis
- D. Restenosis after carotid endarterectomy
- E. Bilateral carotid artery stenosis requiring treatment (Treatment of the contralateral vessel must be scheduled at least 30 days post index procedure).
- F. Hostile Necks which the Investigator deems safe for transcarotid access including:
 - I. Prior neck irradiation
 - II. Radical neck dissection
 - III. Cervical spine immobility

Clinical High Risk Inclusion Criteria:

- G. Patient is \geq 75 years of age
- H. Patient has \geq 2-vessel coronary artery disease and history of angina
- I. Patient has a history of angina
 - Canadian Cardiovascular Society (CCS) angina class 3 or 4
 - or
 - unstable angina
- J. Patient has congestive heart failure (CHF) - New York Heart Association (NYHA)
 - Functional Class III or IV
- K. Patient has known severe left ventricular dysfunction
 - LVEF <30%.
- L. Patient has had a myocardial infarction > 72 hours and < 6 weeks prior to procedure.

- M. Patient has severe pulmonary disease (COPD) with either:
 - FEV1 <50% predicted or
 - chronic oxygen therapy or
 - resting PO2 of ≤60mmHg (room air)
- N. Patient has permanent contralateral cranial nerve injury
- O. Patient has chronic renal insufficiency (serum creatinine > 2.5 mg/dL).

The following effectiveness endpoints were assessed 0 to 30 days in the lead-in and ITT pivotal populations comprised of subjects deemed to be at high risk for complications from CEA and treated with the PRECISE Stent System:

- Acute Device Success
- Technical Success
- Procedural Success

The following safety endpoints were assessed 0 to 30 days in the lead-in and ITT populations comprised of subjects deemed to be at high risk for complications from CEA and treated with the PRECISE System:

- Major Adverse Events (stroke, death and myocardial infarction)
- Adverse Events
- Access Site Complications

Compulsory clinical follow-up included neurological examinations (NIH Stroke Scale, Barthel ADL Index, Modified Rankin Scale, and Cranial Nerve Palsy assessment), duplex ultrasound, and laboratory assessments of cardiac enzymes and 12-lead EKG. Subjects who were suspected of having a stroke were asked to return at 3 months post-procedure for a follow-up neurological exam. Subjects suspected of having a procedure related cranial nerve injury were asked to return at 6 months post-procedure for a follow up neurological examination.

Patient follow-up and accountability are presented in the following table for the sub-study populations:

**Table 5
Patient Follow-Up and Accountability**

Patient Population in ROADSTER	30-Day Follow-Up		90-Day Follow-Up ¹		6-Month Follow-Up ²	
	N	%	N	%	N	%
All PRECISE Stent Patients, Lead-in and Pivotal	52/52	100%	1/1	100%	N/A	N/A
All PRECISE Stent Patients, Combined (Lead-in, Pivotal, and Continued Access)	77/77	100%	1/2	50%	N/A	N/A

Patient demographics in the sub-study population are presented in the following table:

¹ For only those subjects suspected of having a stroke. One patient expired prior to 90 days.

² For only those patients suspected of having a Cranial Nerve Injury (CNI)

Table 6
Patient Demographics in the Sub-Study Population

Observation	All PRECISE Stent Patients in ROADSTER, Lead-in and Pivotal (n=52)	All PRECISE Stent Subjects in ROADSTER, Combined (n=77)
Age (Years)	73.0 ± 9.07	73.0 ± 8.22
Symptomatic	23.1%	19.5%
Male	57.7%	57.1%
Diabetes	34.6%	32.5%
Hypertension	94.2%	94.8%
History of Peripheral Artery Disease	34.6%	32.5%
History of Coronary Artery Disease	48.1%	46.8%
History of Angina	19.2%	14.3%
Congestive Heart Failure	11.5%	11.7%
Recent MI	1.9%	2.6%
Severe Pulmonary Disease	9.6%	10.4%
Dyslipidemia	88.5%	92.2%
History of Stroke	15.4%	16.9%
History of TIA	21.2%	18.2%
History of Amaurosis Fugax	13.5%	10.4%
Current Nicotine Use	25.0%	23.4%
Age >75 Years	51.9%	49.4%
Age >80 Years	23.1%	20.8%
Contralateral Carotid Occlusion	9.6%	6.5%
High Cervical Carotid Stenosis	15.4%	13.0%
Restenosis after CEA	28.8%	32.5%
Bilateral Stenosis Requiring Treatment	32.7%	27.3%
Hostile Neck	15.4%	13.0%
>2 Vessel Coronary Disease	7.7%	7.8%
Chronic Renal Insufficiency	1.9%	1.3%

The primary effectiveness outcomes include acute device success, technical success, and procedural success. In the combined sub-study population (lead-in, pivotal and Continued Access), acute device success was defined as the ability to insert the device, establish flow reversal, and remove the device was 100%. Technical success defined as acute device success plus the ability to deliver interventional tools was 100% in the combined sub-study population. Procedural success defined as technical success in the absence of a Major Adverse Event (S/D/MI) was 96.1% in the combined sub-study population which is comparable to the entire pivotal cohort of the ROADSTER study (n=141; 95.7%).

Table 7: ROADSTER Sub-study - Summary of Baseline Vessel and Lesion Characteristics

Observation	All PRECISE Stent Subjects, Lead-in and Pivotal (n=52)	All PRECISE Stent Subjects, Combined (n=77)
Target Lesion Location		
Left	27 (51.9%)	32 (41.6%)
Right	25 (48.1%)	42 (54.5%)
Vessel to be Treated		
ICA	37 (71.2%)	56 (72.7%)
ICA + CCA	15 (28.8%)	21 (27.3%)
Distance between clavicle and bifurcation (cm)		
N	52	77
Mean	6.6	6.8
Standard Deviation	1.21	1.42
Median	6.5	6.5
Minimum, Maximum	5, 10	5, 12
95% Confidence Interval	(6.3, 6.9)	(6.8, 7.1)
Target Vessel Calcification		
Normal	26 (50.0%)	33 (42.9%)
Mild	17 (32.7%)	24 (31.2%)
Moderate	6 (11.5%)	11 (14.3%)
Severe	1 (1.9%)	7 (9.1%)
Unknown / NA	2 (3.8%)	2 (2.6%)
Target Vessel Tortuosity		
Normal	10 (19.2%)	16 (20.8%)
Mild	26 (50.0%)	42 (54.5%)
Moderate	10 (19.2%)	12 (15.6%)
Severe	2 (3.8%)	3 (3.9%)
Unknown / NA	4 (7.7%)	4 (5.2%)
Pre-Procedure Vessel Diameter (mm)		
N	52	77
Mean	6.7	7.3
Standard Deviation	1.78	1.88
Median	6.8	7.2
Minimum, Maximum	4, 11	4, 13.5
95% Confidence Interval	(6.2, 7.2)	(16.9, 20.7)
Target Lesion Length (mm)		
N	52	77
Mean	18.7	18.8
Standard Deviation	8.05	8.68
Median	17.6	17.4
Minimum, Maximum	5, 39	1.2, 39
95% Confidence Interval	(16.4, 20.9)	(16.9, 20.7)
Pre-Procedure Percent Stenosis (%)		
N	52	77
Mean	86.1	86.8
Standard Deviation	9.01	8.4
Median	90.0	90.0
Minimum, Maximum	60, 99	60, 99
95% Confidence Interval	(83.6, 88.6)	(84.9, 88.7)

Table 8
Acute Device, Technical and Procedural Success in Subjects Treated with the PRECISE Stent

Observations	All PRECISE Stent Subjects, Lead-in and Pivotal (n=52)	All PRECISE Stent Subjects, Combined (n=77)
Acute Device Success	52 (100%)	77 (100%)
Technical Success	52 (100%)	77 (100%)
Procedural Success	51 (98.1%)	74 (96.1%)

The Major Adverse Event rate in the sub-study population (subjects treated with a combination of the PRECISE Stent System and the ENROUTE Transcatheter NPS, (n=77)) was 3.9%. Two sub-study subjects experienced a minor ipsilateral stroke and one patient experienced a myocardial infarction within the 30-day follow-up period. The following table presents the Major Adverse Event rate in the sub-study population along with other endpoints from the ROADSTER study:

Table 9
Major Adverse Event Rate

Observations (at 30 days)	All PRECISE Stent Patients in ROADSTER, Lead-in and Pivotal (n=52)	All PRECISE Stent Patients in ROADSTER, Combined (n=77)
PRIMARY ENDPOINTS		
Safety:		
30 Day MAE (Stroke, Death, or MI)	1 (1.9%)	3 (3.9%)
Effectiveness:		
Acute Device Success	52 (100%)	77 (100%)
Technical Success	52 (100%)	77 (100%)
Procedural Success	51 (98.1%)	74 (96.1%)
SECONDARY ENDPOINTS		
All Death (non-hierarchical)	0 (0.0%)	0 (0.0%)
All Stroke (non-hierarchical)	1 (1.9%)	2 (2.6%)
All Myocardial Infarction (non-hierarchical)	0 (0.0%)	1 (1.3%)
All Cardiac Death (non-hierarchical)	0 (0.0%)	0 (0.0%)
Ipsilateral Stroke (non-hierarchical)	1 (1.9%)	2 (2.6%)
Access Site Complications		
Oozing	0 (0.0%)	0 (0.0%)
Limited Surgical Wound Hematoma	0 (0.0%)	0 (0.0%)
Surgical Wound Hematoma	0 (0.0%)	0 (0.0%)
Arterial Access Site Hematoma	0 (0.0%)	0 (0.0%)
Femoral Vein Access Site Hematoma	0 (0.0%)	2 (2.6%)
Re-bleeding	1 (1.9%)	1 (1.3%)
Contrast Usage (cc)		
N	47	71
Mean	66.1	72.97
Standard Deviation	42.14	55.43
Median	55.0	56.0
Minimum, Maximum	12, 220	12, 350

Table 10a: Summary of All Adverse Events (Sub-study Subjects) (ITT)

System Organ Class Preferred Term	All PRECISE Stent Subjects in the Lead-in and Pivotal population (n=52)	All PRECISE Stent Subjects in the Continued Access Population (n=25)	All PRECISE Stent Subjects in ROADSTER, Combined (n=77)
Number (%) of Subjects with one or more Adverse Events	21 (40.4%)	11 (44.0%)	32 (41.6%)
Blood And Lymphatic System Disorders	2 (3.8%)	1 (4.0%)	3 (3.9%)
Anaemia	2 (3.8%)	1 (4.0%)	3 (3.9%)
Cardiac Disorders	1 (1.9%)	3 (12.0%)	4 (5.2%)
Atrial Fibrillation	1 (1.9%)	0 (0.0%)	1 (1.3%)
Bradycardia	0 (0.0%)	2 (8.0%)	2 (2.6%)
Cardiac Arrest	0 (0.0%)	1 (4.0%)	1 (1.3%)
Cardiac Failure Congestive	1 (1.9%)	0 (0.0%)	1 (1.3%)
Myocardial Infarction	0 (0.0%)	1 (4.0%)	1 (1.3%)
Gastrointestinal Disorders	6 (11.5%)	0 (0.0%)	6 (7.8%)
Nausea	5 (9.6%)	0 (0.0%)	5 (6.5%)
Vomiting	3 (5.8%)	0 (0.0%)	3 (3.9%)
General Disorders And Administration Site Conditions	5 (9.6%)	3 (12.0%)	8 (10.4%)
Pain	5 (9.6%)	1 (4.0%)	6 (7.8%)
Vessel puncture site haematoma	0 (0.0%)	2 (8.0%)	2 (2.6%)
Infections And Infestations	3 (5.8%)	3 (12.0%)	6 (7.8%)
Adenoviral Upper Respiratory Infection	1 (1.9%)	0 (0.0%)	1 (1.3%)
Bronchitis	0 (0.0%)	2 (8.0%)	2 (2.6%)
Infection	1 (1.9%)	0 (0.0%)	1 (1.3%)
Upper Respiratory Tract Infection	0 (0.0%)	1 (4.0%)	1 (1.3%)
Urinary Tract Infection	1 (1.9%)	0 (0.0%)	1 (1.3%)
Injury, Poisoning And Procedural Complications	1 (1.9%)	0 (0.0%)	1 (1.3%)
Post Procedural Haemorrhage	1 (1.9%)	0 (0.0%)	1 (1.3%)
Investigations	3 (5.8%)	0 (0.0%)	3 (3.9%)
Blood Creatine Phosphokinase Increased	1 (1.9%)	0 (0.0%)	1 (1.3%)
Oxygen Saturation Decreased	1 (1.9%)	0 (0.0%)	1 (1.3%)
Troponin Increased	1 (1.9%)	0 (0.0%)	1 (1.3%)
Metabolism and Nutrition Disorders	1 (1.9%)	1 (4.0%)	2 (2.6%)
Dehydration	0 (0.0%)	1 (4.0%)	1 (1.3%)
Hypomagnesaemia	1 (1.9%)	0 (0.0%)	1 (1.3%)
Hypophosphataemia	1 (1.9%)	0 (0.0%)	1 (1.3%)
Nervous System Disorders	4 (7.7%)	2 (8.0%)	6 (7.8%)
Cerebrovascular Accident	1 (1.9%)	0 (0.0%)	1 (1.3%)
Headache	3 (5.8%)	1 (4.0%)	4 (5.2%)
Ischemic Stroke	0 (0.0%)	1 (4.0%)	1 (1.3%)
Psychiatric Disorders	1 (1.9%)	0 (0.0%)	1 (1.3%)
Hallucination, Visual	1 (1.9%)	0 (0.0%)	1 (1.3%)
Renal and urinary disorder	0 (0.0%)	1 (4.0%)	1 (1.3%)
Urinary retention	0 (0.0%)	1 (4.0%)	1 (1.3%)
Respiratory, Thoracic And Mediastinal Disorders	3 (5.8%)	1 (4.0%)	4 (5.2%)
Atelectasis	1 (1.9%)	0 (0.0%)	1 (1.3%)
Dyspnoea	0 (0.0%)	1 (4.0%)	1 (1.3%)
Rales	1 (1.9%)	0 (0.0%)	1 (1.3%)
Rhinorrhoea	1 (1.9%)	0 (0.0%)	1 (1.3%)
Wheezing	1 (1.9%)	0 (0.0%)	1 (1.3%)
Skin and Subcutaneous Tissue Disorders	0 (0.0%)	1 (4.0%)	1 (1.3%)
Skin Irritation	0 (0.0%)	1 (4.0%)	1 (1.3%)
Vascular Disorders	8 (15.4%)	3 (12.0%)	11 (14.3%)
Artery Dissection	1 (1.9%)	0 (0.0%)	1 (1.3%)
Haemorrhage	0 (0.0%)	1 (4.0%)	1 (1.3%)
Hypotension	6 (11.5%)	2 (8.0%)	8 (10.4%)
Orthostatic Hypotension	1 (1.9%)	0 (0.0%)	1 (1.3%)

Table 10b: Summary of All Adverse Events (Sub-study Subjects) (PP)

System Organ Class Preferred Term	All PRECISE Stent Subjects in the Lead-in and Pivotal population (n=48)	All PRECISE Stent Subjects in the Continued Access Population (n=20)	All PRECISE Stent Subjects in ROADSTER Combined (n=68)
Number (%) of Subjects with one or more Adverse Events	19 (39.6%)	9 (45.0%)	28 (41.2%)
Blood And Lymphatic System Disorders	2 (4.2%)	1 (5.0%)	3 (4.4%)
Anaemia	2 (4.2%)	1 (5.0%)	3 (4.4%)
Cardiac Disorders	1 (2.1%)	1 (5.0%)	2 (2.9%)
Atrial Fibrillation	1 (2.1%)	0 (0.0%)	1 (1.5%)
Bradycardia	0 (0.0%)	1 (5.0%)	1 (1.5%)
Cardiac Failure Congestive	1 (2.1%)	0 (0.0%)	1 (1.5%)
Gastrointestinal Disorders	6 (12.5%)	0 (0.0%)	6 (8.8%)
Nausea	5 (10.4%)	0 (0.0%)	5 (6.5%)
Vomiting	3 (6.3%)	0 (0.0%)	3 (4.4%)
General Disorders And Administration Site Conditions	4 (8.3%)	2 (10.0%)	6 (8.8%)
Pain	5 (10.4%)	1 (5.0%)	6 (8.8%)
Vessel puncture site haematoma	0 (0.0%)	1 (5.0%)	1 (1.5%)
Infections And Infestations	3 (6.3%)	2 (10.0%)	5 (7.4%)
Adenoviral Upper Respiratory Infection	1 (2.1%)	0 (0.0%)	1 (1.5%)
Bronchitis	0 (0.0%)	1 (5.0%)	1 (1.5%)
Infection	1 (2.1%)	0 (0.0%)	1 (1.5%)
Upper Respiratory Tract Infection	0 (0.0%)	1 (5.0%)	1 (1.5%)
Urinary Tract Infection	1 (2.1%)	0 (0.0%)	1 (1.5%)
Injury, Poisoning And Procedural Complications	1 (2.1%)	0 (0.0%)	1 (1.5%)
Post Procedural Haemorrhage	1 (2.1%)	0 (0.0%)	1 (1.5%)
Investigations	3 (6.3%)	0 (0.0%)	3 (4.4%)
Blood Creatine Phosphokinase Increased	1 (2.1%)	0 (0.0%)	1 (1.5%)
Oxygen Saturation Decreased	1 (2.1%)	0 (0.0%)	1 (1.5%)
Troponin Increased	1 (2.1%)	0 (0.0%)	1 (1.5%)
Metabolism and Nutrition Disorders	1 (2.1%)	1 (5.0%)	2 (2.9%)
Dehydration	0 (0.0%)	1 (5.0%)	1 (1.5%)
Hypomagnesaemia	1 (2.1%)	0 (0.0%)	1 (1.5%)
Hypophosphataemia	1 (2.1%)	0 (0.0%)	1 (1.5%)
Nervous System Disorders	3 (6.3%)	1 (5.0%)	1 (1.5%)
Headache	3 (6.3%)	1 (5.0%)	1 (1.5%)
Psychiatric Disorders	1 (2.1%)	0 (0.0%)	1 (1.5%)
Hallucination, Visual	1 (2.1%)	0 (0.0%)	1 (1.5%)
Renal and urinary disorder	0 (0.0%)	1 (5.0%)	1 (1.5%)
Urinary retention	0 (0.0%)	1 (5.0%)	1 (1.5%)
Respiratory, Thoracic And Mediastinal Disorders	4 (8.3%)	1 (5.0%)	5 (7.4%)
Atelectasis	1 (2.1%)	0 (0.0%)	1 (1.5%)
Dyspnoea	1 (2.1%)	1 (5.0%)	2 (2.9%)
Rales	1 (2.1%)	0 (0.0%)	1 (1.5%)
Rhinorrhoea	1 (2.1%)	0 (0.0%)	1 (1.5%)
Wheezing	1 (2.1%)	0 (0.0%)	1 (1.5%)
Skin and Subcutaneous Tissue Disorders	0 (0.0%)	1 (5.0%)	1 (1.5%)
Skin Irritation	0 (0.0%)	1 (5.0%)	1 (1.5%)
Vascular Disorders	8 (14.6%)	1 (5.0%)	9 (13.2%)
Artery Dissection	1 (2.1%)	0 (0.0%)	1 (1.5%)
Haemorrhage	0 (0.0%)	1 (5.0%)	1 (1.5%)
Hypotension	6 (12.5%)	0 (0.0%)	6 (8.8%)
Orthostatic Hypotension	1 (2.1%)	0 (0.0%)	1 (1.5%)

The patient demographics and results from the ROADSTER sub-study including subjects receiving the PRECISE stent (n=77) were comparable to those of the ROADSTER ITT Population (pivotal and Continued Access study cohorts, combined, n=219).

8.2 The ROADSTER 2 Post-Approval Study

Accountability

The ROADSTER 2 study protocol calls for an analysis of subjects who underwent the study procedure, independent of the success of the procedure and in the absence of major protocol deviations (Per Protocol Analysis). The analysis of the PP population excludes those subjects for whom a major protocol deviation was identified by the CEC. A majority of these protocol deviations related to medication compliance (see Figure 2 below for additional details). Hence, there are 60 subjects in the overall enrollment cohort, herein referred to the ITT population, that are excluded from the PP analysis. Of the 692 patients enrolled, 632 patients exited the study without a major protocol deviation. In the PP cohort, 98.9% of the patients completed the 30-day follow-up. In the ITT cohort, 98.0% of the patients completed the 30-day follow-up.

Table 11: Subject Disposition

	All Enrolled Patients (N=692)
Reason Patient Exited the Study (ITT)	
30-Day follow-up completed	678 (98.0%)
Patient was removed from the study by the Investigator	2 (0.3%)
Patient withdrew consent	1 (0.1%)
Patient expired	3 (0.4%)
Patient refused further follow-up	8 (1.2%)
Patient Part of the Per Protocol Population	
Yes	632 (91.3%)
30-Day follow-up completed	625 (98.9%)
Patient expired	1 (0.2%)
Patient refused further follow-up	6 (0.9%)

Figure 2. Analysis Cohorts

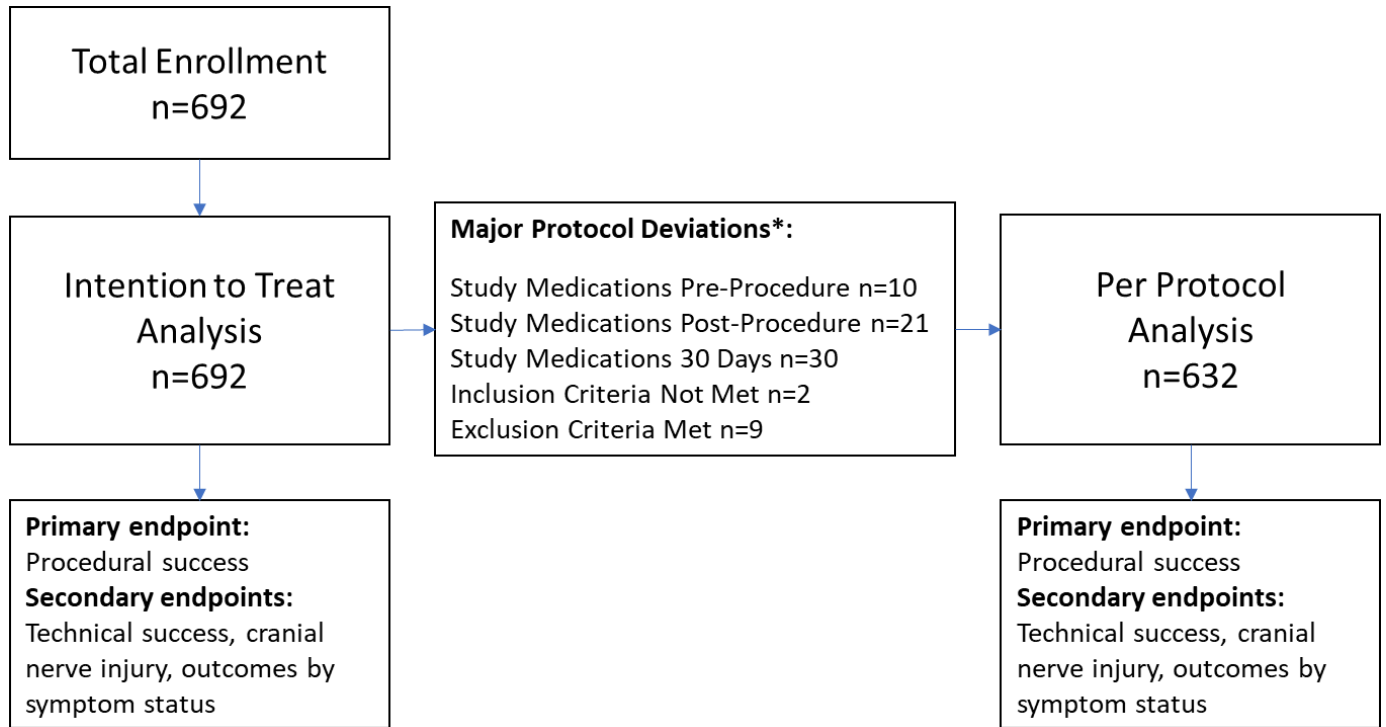

*There were 72 major protocol deviations identified in 60 patients.

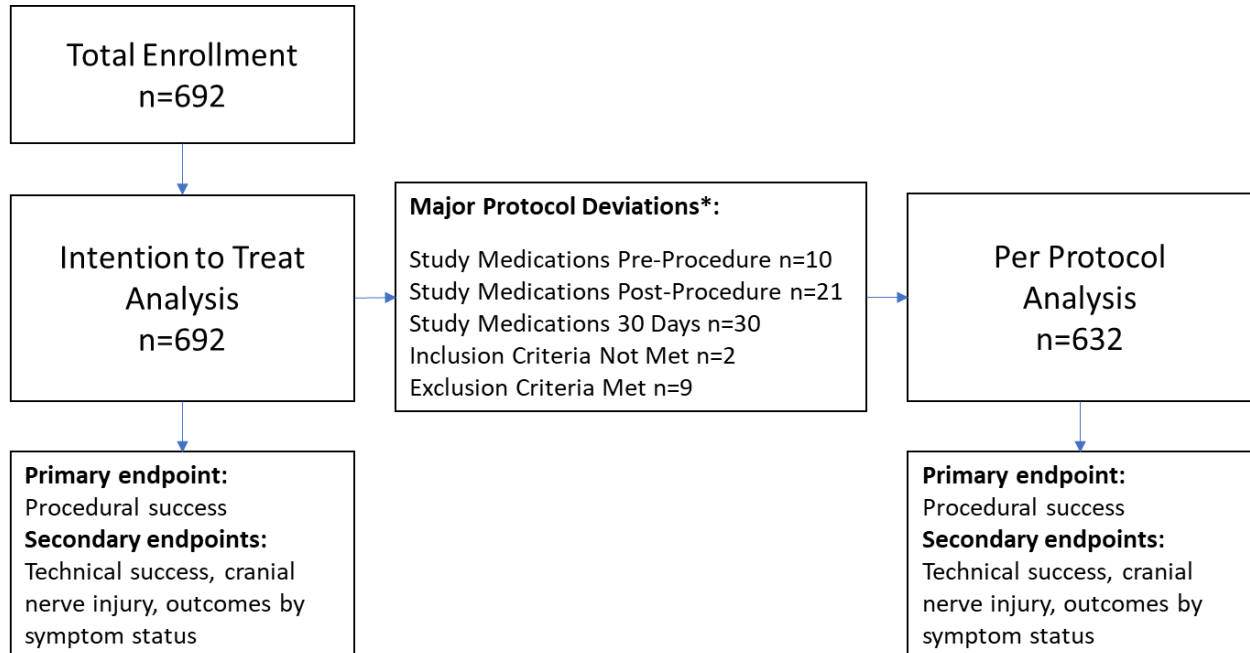

*There were 72 major protocol deviations identified in 60 patients.

Summary of the Post-Approval Study Methods

Study Objective: The intent of the ROADSTER 2 study was to evaluate real world usage of the ENROUTE Transcarotid Stent when used in conjunction with the ENROUTE NPS by physicians of varying levels of training and previous experience with the transcarotid approach.

Study Design: The ROADSTER 2 Study was an open label, single arm, multi-center Post-Approval Study (PAS) evaluating the treatment of patients at high risk for adverse events from carotid endarterectomy who require carotid revascularization and who are eligible for treatment with a combination of the ENROUTE Stent and the ENROUTE NPS in transcarotid artery revascularization (TCAR) procedures. Conduct of the ROADSTER 2 PAS was a condition of FDA approval for the ENROUTE Stent.

Study Population: The study population consisted of male and female subjects at least 18 years of age with atherosclerotic extracranial internal carotid artery (ICA) stenosis, with or without involvement of the contiguous common artery (CCA), determined by duplex ultrasound, CT/CTA, MR/MRA or angiography. Eligible patients were considered at high risk for complications from CEA. The pre-operative inclusion and exclusion criteria follow below.

Data Source: A custom electronic data capture system was implemented based upon FDA-approved case report forms. Data was entered by the participating sites from source documentation and patient medical records.

Monitoring visits to the sites were made periodically for the purpose of assessing compliance with the protocol and GCP guidelines and to verify the data recorded on the electronic Case Report Forms (eCRFs). A risk-based model of monitoring was employed. The source documents were retained at the investigational centers. Medical monitoring ensured that all medical data were valid and reliable. Medical monitoring was designed to provide early recognition, identification, and reporting of issues that could have impacted subject safety, health and well-being.

A Clinical Events Committee (CEC) was established and major adverse events were adjudicated and reviewed as specified in the protocol. The CEC Charter is on file at Silk Road Medical.

All statistical analyses were completed in accordance with a prespecified Statistical Analysis Plan.

Key Study Endpoints:

Primary

The primary endpoint was the rate of procedural success through 30 days following stent implant.

- Procedural success is defined as technical success in the absence of hierarchical stroke, death or myocardial infarction.

Secondary

The following secondary endpoints were assessed 0 to 30 days:

- Acute device success
- Technical success
- Rate of cranial nerve injury
- Rate of cardiac death
- Rate of neurological death
- Rate of hierarchical ipsilateral stroke, death and MI
- Rate of hierarchical ipsilateral stroke, death and MI by symptom status
- Acute device, technical and procedural success by physician experience
- Acute device, technical and procedural success by physician training level
- Acute device, technical and procedural success by enrollment quartile

Total number of Enrolled Study Sites and Subjects, Follow-up Rate: Forty-one (41) sites in the United States of America and two (2) in the European Union enrolled subjects in the ROADSTER 2 study. Eighty-five (85) investigators enrolled patients in ROADSTER 2.

Six hundred thirty-two (632) patients at high risk for complications from CEA were enrolled and treated per protocol between October 2015 and April 2019. An additional 60 patients were enrolled but were excluded from the Per Protocol (PP) analysis due to major protocol deviations.

Of the 692 patients enrolled, 632 patients exited the study without a major protocol deviation. In the PP cohort, 98.9% of the patients completed the 30-day follow-up. In the ITT cohort, 98.0% of the patients completed the 30-day follow-up.

Study visits and length of follow-up: Subjects were followed for 30 days post-procedure. Subjects suspected of having a procedure related cranial nerve injury were asked to return at 3 months post-procedure for a follow-up neurological examination.

Summary of the Post-Approval Study Results

Final safety findings (key endpoints):

Adverse Events

In the Per Protocol (PP) cohort, there were eight (8) adverse events beyond death, stroke, myocardial infarction and cranial nerve injury. Seven (7) of these events were arterial dissections (1.1%). Two (2) arterial dissections were converted to CEA (0.3%). The remaining event was stent thrombosis (0.2%). None of the adverse events led to study discontinuation.

In the ITT cohort, there were ten (10) adverse events beyond death, stroke, myocardial infarction and cranial nerve injury compared to eight (8) in the PP cohort. Nine (9) of these events were arterial dissections (1.3%). Two (2) arterial dissections were converted to CEA (0.3%). The remaining event was stent thrombosis (0.1%).

Table 12: Summary of Adverse Events by Event Type – PP and ITT Populations

Parameters and Statistics	Per Protocol Population (N=632)	Intention to Treat Population (N=692)
Incidence of Unique Adverse Events	27 (4.3%)	45 (6.5%)
Cranial Nerve Injury	8 (1.3%)	10 (1.4%)
Death - Neurological	0 (0%)	2 (0.3%)
Death - Other	1 (0.2%)	1 (0.1%)
Myocardial infarction	6 (0.9%)	7 (1.0%)
NPS device related event	2 (0.3%)	2 (0.3%)
Possibly NPS/Stent device related event	5 (0.8%)	7 (1.0%)
Stent device related event	1 (0.2%)	1 (0.1%)
Stroke, Contralateral	1 (0.2%)	1 (0.1%)
Stroke, Ipsilateral	3 (0.5%)	14 (2.0%)

For the PP cohort, the site-reported relationship of the adverse events to the study device are presented in the following table:

Table 13: Summary of Adverse Events by Type and Device Relationship

Unique Adverse Events	Relationship to the Study Device	Per Protocol Population (N=632)	Intention to Treat Population (N=692)
Death - Neurological	Unknown	0 (0%)	1 (0.1%)
Death - Neurological	Unrelated	0 (0%)	1 (0.1%)

Death - Other	Unrelated	1 (0.2%)	1 (0.1%)
Cranial Nerve Injury	Unrelated	7 (1.1%)	9 (1.3%)
Cranial Nerve Injury	Related	1 (0.2%)	1 (0.1%)
Myocardial infarction	Unrelated	6 (0.9%)	7 (1.0%)
NPS device related event	Related	2 (0.3%)	2 (0.3%)
Possibly NPS/Stent device related event	Unknown	1 (0.2%)	1 (0.1%)
Possibly NPS/Stent device related event	Unrelated	1 (0.2%)	2 (0.3%)
Possibly NPS/Stent device related event	Possibly Related	2 (0.3%)	3 (0.4%)
Possibly NPS/Stent device related event	Probably Related	1 (0.2%)	1 (0.1%)
Stent device related event	Possibly Related	1 (0.2%)	1 (0.1%)
Stroke, Contralateral	Unrelated	1 (0.2%)	1 (0.1%)
Stroke, Ipsilateral	Unrelated	2 (0.3%)	7 (1.0%)
Stroke, Ipsilateral	Probably Related	1 (0.2%)	2 (0.3%)
Stroke, Ipsilateral	Possibly Related	0 (0%)	2 (0.3%)
Stroke, Ipsilateral	Related	0 (0%)	3 (0.4%)

The clinical outcomes, or major adverse events, observed in ROADSTER 2 were secondary endpoints. These endpoints include the rate of hierarchical stroke, death or myocardial infarction, the rate of hierarchical stroke, death or myocardial infarction by symptom status, the rate of cardiac death and the rate of neurological death.

The 30-day rate of hierarchical stroke, death or myocardial infarction in ROADSTER 2 was 1.7% in the PP population. There were no neurological or cardiac deaths (secondary endpoints) in the PP population. In the PP cohort of the pivotal ROADSTER study, the 30-day rate of hierarchical stroke, death or myocardial infarction was 2.5% (n=203).

The 30-day rate of hierarchical stroke, death or myocardial infarction in ROADSTER 2 was 3.2% in the ITT cohort. The 30-day rate of hierarchical stroke, death or myocardial infarction in the pivotal ROADSTER study was 3.5% in the ITT analysis.

Table 14: Hierarchical Major Adverse Events - PP and ITT Populations

Parameters and Statistics	Per-Protocol Population (N=632)	Intention to Treat Population (N=692)
Number of Patients Who Experienced an MAE		
N (%)	11 (1.7%)	22 (3.2%)
95% Exact Binomial Confidence Intervals	(0.87, 3.09)	(2.00, 4.77)
p-value	0.0000	0.0000
Number of Patients Who Died Within 30 Days of the Index Procedure		
N (%)	1 (0.2%)	3 (0.4%)
Number of Patients Who had a Stroke Within 30 Days of the Index Procedure		
N (%)	4 (0.6%)	13 (1.9%)
Number of Patients Who had an MI Within 30 Days of the Index Procedure		
N (%)	6 (0.9%)	6 (0.9%)

In the pivotal ROADSTER study, the rate of 30-day hierarchical stroke, death or myocardial infarction (primary endpoint) was compared to an *a priori* threshold of 11%. For reference, the same analysis for ROADSTER 2 is presented above. The upper bound of the 2-sided 95% exact binomial confidence intervals of the observed major adverse event rate is significantly lower than the *a priori* threshold of 11% (p<0.0001).

Unanticipated Adverse Device Effects

Unanticipated adverse device effects are defined as any serious adverse effect on health, safety or any life-threatening problem or death caused by, or associated with the study device if that effect, problem, or death was not previously identified in nature, severity or degree of incidence in the study protocol and informed consent. There were no unanticipated adverse device effects in ROADSTER 2.

Final effectiveness findings (key endpoints):

Primary

The primary endpoint of ROADSTER 2 is the rate of procedural success in patients treated per protocol through 30 days following the index procedure. Procedural success is defined as acute device success (successful insertion of the ENROUTE NPS and establishment of flow reversal), technical success (deployment of interventional tools) and the absence of a major adverse events (hierarchical stroke/death/myocardial infarction) through 30 days.

The observed rate of procedural success in the ROADSTER 2 Study is compared to an *a priori* threshold of 85% derived from the ROADSTER Study. The rationale for an 85% threshold is based on the lower bound of the 2-sided 95% exact binomial confidence intervals of the procedural success rates from the ROADSTER Lead-In Phase (91.0%, 95% CI 81.52%, 96.64%) and the ROADSTER Pivotal Phase (95.7%, 95% CI 90.97%, 98.42%). With an observed rate of procedural success >89% in ROADSTER 2, the results would be significant with a minimum of 600 patients, meaning the lower bound of the 2-sided 95% exact binomial confidence interval exceeded 85%.

The lower bound of the 2-sided 95% exact binomial confidence intervals of the observed procedural success rate significantly exceeds the *a priori* threshold of 85% ($p < 0.0001$). The primary endpoint of ROADSTER 2 has been met.

Table 15: Procedural Success - PP and ITT Populations

Parameters and Statistics	Per-Protocol Population (N=632)	Intention to Treat Population (N=692)
Number of Patients Who Achieved Procedure Success		
N (%)	619 (97.9%)	668 (96.5%)
95% Exact Binomial Confidence Intervals	(96.51, 98.90)	(94.88, 97.77)
p-value	0.0000	0.0000
Number of Patients Who Achieved Technical Success		
N (%)	630 (99.7%)	690 (99.7%)
Number of Patients Who Achieved Acute Device Success		
N (%)	630 (99.7%)	690 (99.7%)

Secondary

Major adverse events (stroke, death, myocardial infarction) were secondary endpoints and are described in the safety analysis above. In the PP cohort, there were 166 symptomatic patients and 466 asymptomatic patients enrolled in ROADSTER 2. The 30-day rate of major adverse events (hierarchical stroke/death/myocardial infarction) in the symptomatic cohort was 1.2% and 1.9% in the asymptomatic cohort in the PP population. In the ITT cohort, there were 180 symptomatic patients and 512 asymptomatic enrolled in ROADSTER 2. The 30-day rate of major adverse events (hierarchical stroke/death/myocardial infarction) in the symptomatic cohort was 5.6% and 2.3% in the asymptomatic cohort in the ITT population.

Procedural success rates by physician levels were 98.6%, 90.9% and 91.7% for Levels 1, 2 and 3 respectively in the PP population. Procedural success rates by physician levels were 97.2%, 87.5% and 89.5% for Levels 1, 2 and 3 respectively in the ITT population. The procedural success rates for Levels 2 and 3 are lower than that for Level 1, yet the acute device and technical success rates for Levels 2 and 3 were 100% in both the PP and ITT cohorts, so the lower rates were not driven by operator/device interaction. In the PP population, it was two (2) major adverse events in Level 2 and three (3) major adverse events in Level 3 that impacted the procedural success rates for

those levels. In the ITT population, it was three (3) major adverse events in Level 2 and four (4) major adverse events in Level 3 that impacted the procedural success rates for those levels. While ROADSTER 2 was not powered to compare procedural success rates by physician training levels, it is worth noting that the primary endpoint (procedural success) was compared to an *a priori* threshold of 85%.

Table 16: Acute Device, Technical and Procedural Success by Physician Level of Training – PP Population

Parameters and Statistics	Level 1 Training (N=554)	Level 2 Training (N=22)	Level 3 Training (N=36)	Level of Training Not Reported (N=20)
Number of Patients Who Achieved Procedure Success				
N (%)	546 (98.6%)	20 (90.9%)	33 (91.7%)	20 (100.0%)
Number of Patients Who Achieved Technical Success				
N (%)	552 (99.6%)	22 (100.0%)	36 (100.0%)	20 (100.0%)
Number of Patients Who Achieved Acute Device Success				
N (%)	552 (99.6%)	22 (100.0%)	36 (100.0%)	20 (100.0%)

Physician training levels are defined in Figure 3.

Figure 3: Physician Training Levels

	Level 1 Physician	Level 2 Physician	Level 3 Physician
Criteria	<ul style="list-style-type: none"> Attended another manufacturer’s CAS training program <p><i>AND</i></p> <ul style="list-style-type: none"> Successfully performed at least 25 CAS cases <p>OR</p> <p>Performed:</p> <ul style="list-style-type: none"> 10 Endovascular interventions <p><i>AND</i></p> <ul style="list-style-type: none"> 10 Open surgical repairs of a vessel <p><i>AND</i></p> <ul style="list-style-type: none"> 5 CAS cases 	<ul style="list-style-type: none"> Attended another manufacturer’s CAS training program <p><i>AND</i></p> <ul style="list-style-type: none"> Successfully performed at least 5 CAS cases <p>OR</p> <p>Performed:</p> <ul style="list-style-type: none"> 5-10 Endovascular interventions <p><i>AND</i></p> <ul style="list-style-type: none"> 5-10 Open surgical repair of a vessel <p><i>AND</i></p> <ul style="list-style-type: none"> 1-4 CAS cases 	Performed < 5 CAS cases

Rates of acute device, technical and procedural success were tabulated by physician experience with the ENROUTE Stent when used with the ENROUTE Neuroprotection System. Inexperienced physicians are defined as those who did not participate in the pivotal ROADSTER study or the ROADSTER sub-study. Acute device, technical and procedural success rates by inexperienced physicians were 99.5%, 99.5% and 97.2% respectively. Acute device, technical and procedural success rates by experienced physicians were 100%, 100% and 99.2% respectively.

The procedural success rate was fairly stable over enrollment quartiles with the first quartile being the highest (99.4%) and the second quartile being the lowest (96.2%). Each quartile was not markedly different than the overall procedural success rate of 97.9%. There were no major adverse events in the first quartile, six (6) in the second quartile, two (2) in the third quartile and two (2) in the fourth quartile.

For the analysis of cranial nerve injury, this outcome is presented for the entire enrolled (ITT) cohort as the occurrence of a cranial nerve injury is unrelated to the documented occurrence of a major protocol deviation that would exclude those patients. In the ITT cohort, there were ten (10) discrete reports of cranial nerve injury during the periprocedural period (10/692; 1.4%). In the 30-day follow-up period, ten (10) CNIs remained unresolved (1.4%). Of the ten (10) patients with cranial nerve injuries, six (6) patients consented to the extended follow-up. Of the six (6) patients that consented for extended follow-up, all CNIs resolved (60.0%)³. Resolution of the remaining four (4) CNIs is unknown (40%). In the extended follow-up, five (5) CNIs resolved without treatment (50% of reported CNIs) and one (1) CNI resolved with treatment (10% of CNIs). All the abnormal CNI assessments were limited to physician training Level 1. There were no reports of abnormal CNI assessments for physician training Levels 2 and 3.

Study Strength and Weaknesses:

The strengths of the ROADSTER 2 PAS include the larger sample compared to the pivotal ROADSTER study. Acute device, technical and procedural success were presented to show operator/device interaction. Additionally, major adverse events (clinical outcomes) were analyzed in the same manner as in the pivotal ROADSTER study to

³ Of the six (6) patients that underwent an extended follow-up assessment, only one (1) patient returned within the 3-month follow-up window. Of the remaining five (5) patients, the follow-up ranged from 100 days to 402 days.

demonstrate consistency of the results. All major adverse events, which are components of the primary endpoint, were independently adjudicated to ensure a lack of bias in event reporting. More than 60% of enrolling physicians were novices to the transcrotid technique.

The ROADSTER 2 PAS was not randomized thereby lacking a contemporaneous comparator to other carotid revascularization modalities. Enrollment was based upon pre-defined inclusion/exclusion criteria which would otherwise exclude cohorts of patients in whom the safety and efficacy was not assessed. Non-consecutive enrollment could reflect patient selection bias. Low numbers of enrolling physicians in Levels 2 and 3 potentially limit the generalizability of the results.

The ROADSTER 2 study was a prospective, single-arm, multi-center clinical trial of the ENROUTE Transcarotid Stent System in conjunction ENROUTE Transcarotid Neuroprotection System used for revascularization in patients with carotid disease who were at high risk for complications from carotid endarterectomy (CEA). There were 632 subjects enrolled into the per protocol population between October 2015 and April 2019. The study included patients with atherosclerotic extracranial internal carotid stenosis (ICA) with or without involvement of the contiguous common artery (CCA) determined by duplex ultrasound, CT/CTA, MR/MRA or angiography. The study population consisted of male and female subjects at least 18 years of age meeting one of the following criteria regarding neurological symptom status and degree of stenosis:

Symptomatic: Stenosis must be $\geq 50\%$ as determined by angiogram and the patient has a history of stroke (minor or non-disabling), TIA and/or amaurosis fugax within 180 days of the procedure, OR

Asymptomatic: Stenosis must be $\geq 80\%$ as determined by angiogram without any neurological symptoms within the prior 180 days.

Eligible subjects were scheduled to undergo carotid revascularization with the ENROUTE Transcarotid Stent System and the ENROUTE Transcarotid NPS. Subjects were followed for 30 days post-procedure. Patients met at least one of the surgical high-risk criteria listed below.

Anatomic High Risk Inclusion Criteria:

- A. Contralateral carotid artery occlusion
- B. Tandem stenoses $>70\%$
- C. High cervical carotid artery stenosis
- D. Restenosis after carotid endarterectomy
- E. Bilateral carotid artery stenosis requiring treatment (Treatment of the contralateral vessel must be scheduled at least 30 days post index procedure).
- F. Hostile Necks which the Investigator deems safe for transcrotid access including:
 - I. Prior neck irradiation
 - II. Radical neck dissection
 - III. Cervical spine immobility

Clinical High Risk Inclusion Criteria:

- G. Patient is ≥ 75 years of age
- H. Patient has ≥ 2 -vessel coronary artery disease and history of angina of any severity
- I. Patient has a history of angina
 - Canadian Cardiovascular Society (CCS) angina class 3 or 4
 - or
 - unstable angina
- J. Patient has congestive heart failure (CHF) - New York Heart Association (NYHA)
 - Functional Class III or IV
- K. Patient has known severe left ventricular dysfunction
 - LVEF $<30\%$.
- L. Patient has had a myocardial infarction > 72 hours and < 6 weeks prior to procedure.
- M. Patient has severe pulmonary disease (COPD) with either:

- FEV1 <50% predicted or
 - chronic oxygen therapy or
 - resting PO2 of ≤60mmHg (room air)
- N. Patient has permanent contralateral cranial nerve injury
- O. Patient has chronic renal insufficiency (serum creatinine > 2.5 mg/dL).

The following effectiveness endpoints were assessed 0 to 30 days:

- Acute Device Success
- Technical Success
- Procedural Success

The following safety endpoints were assessed 0 to 30 days:

- Major Adverse Events (stroke, death and myocardial infarction)

Compulsory clinical follow-up included neurological examinations (NIH Stroke Scale, Modified Rankin Scale, and Cranial Nerve Palsy assessment) and duplex ultrasound. Subjects suspected of having a procedure related cranial nerve injury were asked to return at 3 months post-procedure for a follow up neurological examination.

Patient follow-up and accountability are presented in the following table:

Table 17
ROADSTER 2 - Patient Disposition (PP and ITT Populations)

	Per Protocol Patients Enrolled (N=632)	All Enrolled Patients (N=692)
30-Day follow-up completed	625 (98.9%)	678 (98.0%)
Patient expired	1 (0.2%)	3 (0.4%)
Patient refused further follow-up	6 (0.9%)	8 (1.2%)
Patient was removed from the study by the Investigator	0 (0%)	2 (0.3%)
Patient withdrew consent	0 (0%)	1 (0.1%)
Physician Level of Training		
Level 1	554 (87.7%)	610 (88.2%)
Level 2	22 (3.5%)	23 (3.3%)
Level 3	36 (5.7%)	38 (5.5%)
Not Reported	20 (3.2%)	21 (3.0%)
Physician Experienced with Using the Study Device		
Yes	241 (38.1%)	264 (38.2%)
No	391 (61.9%)	428 (61.8%)

Patient demographics are presented in the following tables:

Table 18a
ROADSTER 2 - Patient Demographics (PP and ITT Populations)

Observation	Per Protocol Population (N = 632)	Intention to Treat Population (N=692)
Age (Years)		
≤ 64	104 (16.5%)	113 (16.3%)
65-69	128 (20.3%)	140 (20.2%)
70-74	136 (25.2%)	148 (21.4%)
75-79	130 (20.7%)	145 (21.0%)
≥ 80	134 (21.2%)	146 (21.1%)
Symptomatic	26.3%	26.0%

Male	67.7%	67.8%
Diabetes	35.0%	36%
Hypertension	90.3%	90.8%
History of Peripheral Artery Disease	24.7%	25.1%
History of Coronary Artery Disease	14.6%	14.2%
History of Angina	2.1%	1.9%
Congestive Heart Failure	1.9%	1.7%
Recent MI	0.8%	0.7%
Severe Pulmonary Disease	2.8%	2.7%
Dyslipidemia	85.8%	86.3%
History of Stroke	15.7%	16.4%
History of TIA	16.1%	16.0%
History of Amaurosis Fugax	8.5%	8.5%
Current Nicotine Use	21.8%	21.1%
Age ≥75 Years	41.8%	42.1%
Age ≥80 Years	21.2%	21.1%
Contralateral Carotid Occlusion	10.1%	9.7%
High Cervical Carotid Stenosis	28.0%	28.2%
Restenosis after CEA	19.3%	19.5%
Bilateral Stenosis Requiring Treatment	8.2%	7.7%
Hostile Neck Safe for Transcarotid Access	3.8%	3.8%
>2 Vessel Coronary Disease	14.6%	14.2%

Table 18b
ROADSTER 2 - Patient Demographics (PP and ITT Populations)

Parameters and Statistics	Per Protocol Population (N=632)	Intention to Treat Population (N=692)
Age Category		
<=64	104 (16.5%)	113 (16.3%)
65-69	128 (20.3%)	140 (20.2%)
70-74	136 (21.5%)	148 (21.4%)
75-79	130 (20.6%)	145 (21.0%)
>=80	134 (21.2%)	146 (21.1%)
Height (cm)		
N	632	692
Mean	170.3	170.2
Standard Deviation	9.91	9.93
Median	170.2	170.2
Minimum, Maximum	136, 195	136, 195
95% Confidence Interval	(169.5, 171.1)	(169.5, 170.9)
Weight (kg)		
N	632	692
Mean	81.5	81.7
Standard Deviation	18.23	18.48
Median	79.3	79.4
Minimum, Maximum	36, 165	36, 165
95% Confidence Interval	(80.0, 82.9)	(80.3, 83.0)
Gender		
Male	428 (67.7%)	469 (67.8%)
Female	204 (32.3%)	223 (32.2%)
Race		
African American	28 (4.4%)	35 (5.1%)
Asian	5 (0.8%)	7 (1.0%)

Parameters and Statistics	Per Protocol Population (N=632)	Intention to Treat Population (N=692)
Caucasian	560 (88.6%)	605 (87.4%)
Hispanic Or Latino	23 (3.6%)	28 (4.0%)
Mixed Race	2 (0.3%)	2 (0.3%)
Pacific Islander	3 (0.5%)	3 (0.4%)
Unknown / Other	11 (1.7%)	12 (1.7%)

Table 18c High Surgical Risk Inclusion Criteria - Anatomic Risk Factors (PP and ITT Populations)

Parameters and Statistics	Per Protocol Population (N=632)	Intention to Treat Population (N=692)
Contralateral carotid artery occlusion	64 (10.1%)	67 (9.7%)
Tandem stenoses >70%	10 (1.6%)	13 (1.9%)
High cervical carotid artery stenosis	177 (28.0%)	195 (28.2%)
Restenosis after carotid endarterectomy	122 (19.3%)	135 (19.5%)
Bilateral carotid artery stenosis requiring treatment	52 (8.2%)	53 (7.7%)
Hostile Necks safe for transcarotid access	24 (3.8%)	26 (3.8%)

The primary effectiveness outcomes include acute device success, technical success, and procedural success. In the ROADSTER 2 study population, acute device success, defined as the ability to insert the ENROUTE Transcarotid Neuroprotection System, establish flow reversal, and remove the device, was 99.7%. Technical success, defined as acute device success plus the ability to deliver interventional tools, was 99.7%. Procedural success defined as technical success in the absence of a Major Adverse Event (S/D/MI) was 97.9% in the PP population and 96.5% in ITT population, which are comparable to the entire pivotal cohort of the ROADSTER study (n=141; 95.7%).

Table 19 Procedural Success – PP and ITT Populations

Parameters and Statistics	Per-Protocol Population (N=632)	Intention to Treat Population (N=692)
Number of Patients Who Achieved Procedure Success		
N (%)	619 (97.9%)	668 (96.5%)
95% Exact Binomial Confidence Intervals	(96.51, 98.90)	(94.88, 97.77)
p-value	0.0000	0.0000
Number of Patients Who Achieved Technical Success		
N (%)	630 (99.7%)	690 (99.7%)
Number of Patients Who Achieved Acute Device Success		
N (%)	630 (99.7%)	690 (99.7%)

Table 20 ROADSTER 2 - Summary of Baseline Vessel and Lesion Characteristics (PP and ITT Populations)

Parameters and Statistics	Per Protocol Population (N=632)	Intention to Treat Population (N=692)
Previous CEA		
None	465 (73.6%)	501 (72.4%)
Ipsilateral	102 (16.1%)	112 (16.2%)
Contralateral	44 (7.0%)	55 (7.9%)
Ipsilateral + Contralateral	21 (3.3%)	24 (3.5%)
Previous CAS		
None	600 (94.9%)	650 (93.9%)
Contralateral	32 (5.1%)	42 (6.1%)
Ipsilateral carotid artery stenosis		
50 – 59%	8 (1.3%)	8 (1.2%)
60 – 69%	19 (3.0%)	20 (2.9%)
70 – 79%	48 (7.6%)	54 (7.8%)
80 – 89%	327 (51.7%)	361 (52.2%)
90 – 99%	230 (36.4%)	249 (36.0%)
Contralateral carotid artery stenosis		
None	39 (6.2%)	43 (6.2%)
<50%	298 (47.2%)	327 (47.3%)
50 – 59%	93 (14.7%)	98 (14.2%)
60 – 69%	50 (7.9%)	61 (8.8%)
70 – 79%	48 (7.6%)	52 (7.5%)
80 – 89%	17 (2.7%)	19 (2.7%)
90 – 99%	9 (1.4%)	10 (1.4%)
100%	64 (10.1%)	67 (9.7%)
Unknown	14 (2.2%)	15 (2.2%)
Peripheral artery disease		
Yes	156 (24.7%)	174 (25.1%)
No	476 (75.3%)	518 (74.9%)

**Table 21
ROADSTER 2 - Acute Device, Technical and Procedural Success (PP and ITT Populations)**

Observations	Per Protocol Population (N = 632)	Intention to Treat Population (N=692)
Acute Device Success	630 (99.7%)	690 (99.7%)
Technical Success	630 (99.7%)	690 (99.7%)
Procedural Success	619 (97.9%)	668 (96.5%)

The Major Adverse Event rate in the ROADSTER 2 per protocol population was 1.7%. Three subjects experienced an ipsilateral stroke and six subjects experienced a myocardial infarction within the 30-day follow-up period. The following table presents the Major Adverse Event rate in the per protocol and ITT populations along with other endpoints from the ROADSTER 2 study:

Table 22
ROADSTER 2 - Major Adverse Event Rate (PP and ITT Populations)

Observations (at 30 days)	Per Protocol Population (N = 632)	Intention to Treat Population (N=692)
PRIMARY ENDPOINTS		
Safety:		
30 Day MAE (Stroke, Death, or MI)	11 (1.7%)	22 (3.2%)
Effectiveness:		
Acute Device Success	630 (99.7%)	690 (99.7%)
Technical Success	630 (99.7%)	690 (99.7%)
Procedural Success	619 (97.9%)	668 (96.5%)
SECONDARY ENDPOINTS		
All Death (non-hierarchical)	1 (0.2%)	3 (0.4%)
All Stroke (non-hierarchical)	4 (0.6%)	13 (1.9%)
All Myocardial Infarction (non-hierarchical)	6 (0.9%)	6 (0.9%)
All Cardiac Death (non-hierarchical)	0 (0.0%)	0 (0.0%)
Ipsilateral Stroke (non-hierarchical)	3 (0.5%)	14 (2.0%)

8.3 PROPENSITY SCORE MATCHED ANALYSIS OF PATIENTS TREATED WITH TRANSCAROTID ARTERY REVASCULARIZATION (TCAR) AND CAROTID ENDARTERECTOMY (CEA) IN PATIENTS DEEMED TO BE AT STANDARD RISK FOR ADVERSE EVENTS FROM CEA

Objective: The intent of these analyses is to establish reasonable assurance of the safety and effectiveness of the ENROUTE Transcarotid Stent System in patients at standard surgical risk for adverse events from CEA.

Design: Real-World Data (RWD) housed within the Society for Vascular Surgery Vascular Quality Initiative (SVS VQI) were utilized for the analyses presented herein. The analyses establish Real-World Evidence (RWE) to provide reasonable assurance of the safety and effectiveness of the ENROUTE Transcarotid Stent System in standard surgical risk patients during TCAR procedures. Reasonable assurance of safety and effectiveness is demonstrated through an analysis of patient-level data from the CAS and CEA registries of the SVS VQI. Patients deemed to be at standard risk for adverse events from CEA were analyzed in a propensity score matched analysis to provide RWE. Outcomes include major adverse events (death/stroke/myocardial infarction) through 30 days and ipsilateral stroke from 31 days through 365 days. The outcomes are presented as a composite endpoint. Propensity score matching and data analyses were conducted on behalf of the sponsor by a third party that is unaffiliated with the sponsor.

Patient Population: All standard risk CEA and TCAR patients that underwent the procedure from August 8, 2016 through September 2, 2020 that were entered into the SVS VQI CAS and CEA registries were considered for inclusion. A total of 44,743 CEA patients and 5,066 TCAR patients over the period met the criteria for inclusion and were available for the analyses. After matching CEA and TCAR patients in a 3:1 ratio, 15,198 CEA patients and 5,066 TCAR patients were available for the analyses. This includes 2,988 CEA patients and 996 TCAR patients with 1-year follow-up.

Investigators and Study Centers: This is a compilation of data from the SVS VQI CAS and CEA registries. These data represent all centers that participate in either the CAS and/or CEA registries and considered all patients meeting the criteria for inclusion. A single coordinating investigator oversaw the compilation of data and the output.

Composite Primary Endpoint: The composite endpoint to establish reasonable assurance of the safety and effectiveness of the subject device is death/stroke/myocardial infarction through 30 days and ipsilateral stroke from day 31 through day 365.

The objective of the analysis is to determine if TCAR is non-inferior to CEA based on the primary endpoint definition. The null hypothesis and alternative hypothesis are presented below.

Ho: $\pi\text{TCAR} - \pi\text{CEA} \geq \text{non-inferiority margin (\%)}$

Ha: $\pi\text{TCAR} - \pi\text{CEA} < \text{non-inferiority margin (\%)}$

Where

πTCAR represents the percentage of TCAR patients who experience the composite primary endpoint, πCEA represents the percentage of CEA patients who experience the composite primary endpoint, and non-inferiority margin (%) refers to the pre-specified non-inferiority margin.

A non-inferiority margin of 5% was chosen.

The cumulative incidence of the endpoint was estimated among the matched population using Kaplan Meier methods. Statistical inference was performed using the bootstrap method.

Overview

All CEA and TCAR patients that underwent the respective procedures from August 8, 2016 through September 2, 2020 and that were entered into the SVS VQI CAS and CEA registries were considered for inclusion. A total of 44,743 standard surgical risk CEA patients and 5,066 standard surgical risk TCAR patients who received the ENROUTE Stent over the period were available for the analyses. After matching CEA and TCAR patients in a 3:1 ratio, 15,198 CEA patients and 5,066 TCAR patients were available for the analyses. This includes 2,988 CEA patients with 1-year follow-up and 996 TCAR patient with 1-year follow-up that were analyzed for the 1-year endpoint (ipsilateral stroke from day 31 to day 365).

Demographics and Baseline Characteristics (All Matched Patients)

0 provides a tabulation of the baseline demographics for all matched CEA and TCAR patients. Three CEA patients were matched to each TCAR patient (3:1 nearest neighbor, no caliper). There were no TCAR patients treated with the ENROUTE Stent that were excluded from matching. Key demographic parameters were similar between the matched cohorts: symptom status, age, gender, congestive heart failure, COPD, dialysis, smoking, hypertension, kidney function, coronary artery disease and percent stenosis. TCAR patients had a slightly higher mean body mass index based on the arithmetic mean, and a slightly higher incidence of mild coronary artery disease, but neither was considered clinically significant. The median BMI differed by 0.5 (kg/m²) between TCAR and CEA. The incidence of severe stenosis (>70%) was 91.3% and 90.2% for the CEA and TCAR cohorts, respectively.

Table 23 Demographics and Baseline Characteristics after Matching (All Patients)

	Total n = 20264	Treatment Modality		Std Diff (%)
		CEA n = 15198	TCAR n = 5066	
Presenting Symptom Status				1.5
Stroke	6187 (30.5%)	4619 (30.4%)	1568 (31.0%)	
Cortical TIA	2435 (12.0%)	1823 (12.0%)	612 (12.1%)	
Retinal TIA	838 (4.1%)	630 (4.1%)	208 (4.1%)	
Unknown Stroke Severity	1516 (7.5%)	1135 (7.5%)	381 (7.5%)	
Asymptomatic	9288 (45.8%)	6991 (46.0%)	2297 (45.3%)	

	Total	Treatment Modality		Std Diff (%)
	n = 20264	CEA n = 15198	TCAR n = 5066	
Age				3.1
Mean ± SD	70.22 ± 6.72	70.17 ± 6.66	70.38 ± 6.88	
Median (IQR)	72.00 (66.00, 76.00)	71.00 (66.00, 75.00)	72.00 (66.00, 76.00)	
Age ≥65	16360 (80.7%)	12285 (80.8%)	4075 (80.4%)	1.0
Male	12943 (63.9%)	9684 (63.7%)	3259 (64.3%)	1.3
Caucasian	18211 (89.9%)	13670 (89.9%)	4541 (89.6%)	1.0
Race				1.7
American Indian or Alaskan Native	95 (0.5%)	70 (0.5%)	25 (0.5%)	
Asian	160 (0.8%)	122 (0.8%)	38 (0.8%)	
Black or African American	1149 (5.7%)	854 (5.6%)	295 (5.8%)	
Native Hawaiian or other Pacific Islander	17 (0.1%)	12 (0.1%)	5 (0.1%)	
White	18211 (89.9%)	13670 (89.9%)	4541 (89.6%)	
More than 1 race	41 (0.2%)	29 (0.2%)	12 (0.2%)	
Unknown / Other	591 (2.9%)	441 (2.9%)	150 (3.0%)	
Body Mass Index				5.6
Mean ± SD	28.79 ± 8.14	28.68 ± 7.95	29.14 ± 8.68	
Median (IQR)	28.25 (25.01, 32.04)	28.17 (24.98, 31.93)	28.44 (25.09, 32.42)	
Hispanic or Latino	944 (4.7%)	712 (4.7%)	232 (4.6%)	0.5
None vs mild CAD (i.e., without unstable angina or MI within 6 months)	9020 (44.5%)	6657 (43.8%)	2363 (46.6%)	5.7
None vs. Asymptomatic/Mild CHF	2277 (11.2%)	1683 (11.1%)	594 (11.7%)	2.0
None vs mild COPD (i.e., not on home oxygen)	4377 (21.6%)	3273 (21.5%)	1104 (21.8%)	0.6
Dialysis	0 (0.0%)	0 (0.0%)	0 (0.0%)	
ASA Class				1.7
1	112 (0.6%)	84 (0.6%)	28 (0.6%)	
2	748 (3.7%)	562 (3.7%)	186 (3.7%)	
3	14631 (72.2%)	10999 (72.4%)	3632 (71.7%)	
4 or 5	4773 (23.6%)	3553 (23.4%)	1220 (24.1%)	
Smoking				0.9
None	5220 (25.8%)	3904 (25.7%)	1316 (26.0%)	
Prior	10130 (50.0%)	7615 (50.1%)	2515 (49.6%)	
Current	4914 (24.2%)	3679 (24.2%)	1235 (24.4%)	
Hypertension	18184 (89.7%)	13635 (89.7%)	4549 (89.8%)	0.3
Diabetes				1.5
None	12177 (60.1%)	9158 (60.3%)	3019 (59.6%)	
Diet	993 (4.9%)	738 (4.9%)	255 (5.0%)	
Non-Insulin	4098 (20.2%)	3068 (20.2%)	1030 (20.3%)	
Insulin/medication dependent	2996 (14.8%)	2234 (14.7%)	762 (15.0%)	
Prior CABG	3991 (19.7%)	3012 (19.8%)	979 (19.3%)	1.2
Prior PCI	5097 (25.2%)	3827 (25.2%)	1270 (25.1%)	0.3
Creatinine mg/dl				1.5
Mean ± SD	1.03 ± 0.32	1.03 ± 0.32	1.04 ± 0.32	
Median (IQR)	0.98 (0.80, 1.20)	0.98 (0.80, 1.20)	0.99 (0.80, 1.20)	
GFR				1.9
Mean ± SD	75.29 ± 18.60	75.38 ± 18.64	75.03 ± 18.48	
Median (IQR)	79.44 (61.76, 88.92)	79.65 (61.91, 89.03)	78.64 (61.56, 88.48)	
GFR<60	4614 (22.8%)	3448 (22.7%)	1166 (23.0%)	0.8
Pre-admission Living Status				0.4
Home	20018 (98.8%)	15014 (98.8%)	5004 (98.8%)	
Nursing home	220 (1.1%)	164 (1.1%)	56 (1.1%)	
Homeless	26 (0.1%)	20 (0.1%)	6 (0.1%)	
Percent Lesion Stenosis				4.0
> 50%	1257 (6.2%)	907 (6.0%)	350 (6.9%)	
> 60%	560 (2.8%)	417 (2.7%)	143 (2.8%)	
> 70%	2610 (12.9%)	1949 (12.8%)	661 (13.0%)	
> 80%	15837 (78.2%)	11925 (78.5%)	3912 (77.2%)	

Procedure Information (All Matched Patients)

0 provides a tabulation of the procedure information for all matched CEA and TCAR patients by treatment modality. The use of general anesthesia was higher in the CEA cohort. The use of pre-operative P2Y12 antagonists was higher in the TCAR patients which is expected in accordance with multi-society, treatment guidelines following CAS procedures. Mean procedure times were longer for CEA than TCAR (117.30 min vs 72.50 min respectively). The use of dual antiplatelet therapy was higher in the TCAR cohort, which is expected in accordance with multi-society, treatment guidelines following CAS procedures.

Table 24 Procedure Information after Matching (All Patients)

	Total n = 20264	Treatment modality		Std Diff (%)
		CEA n = 15198	TCAR n = 5066	
Lesion Laterality				0.4
Right	10468 (51.7%)	7843 (51.6%)	2625 (51.8%)	
Left	9796 (48.3%)	7355 (48.4%)	2441 (48.2%)	
Lesion Length (mm)				N/A
Mean ± SD	25.46 ± 11.51	Not Reported	25.46 ± 11.51	
Median (IQR)	25.00 (18.00, 30.00)		25.00 (18.00, 30.00)	
Missing			605	
General Anesthesia Use	18387 (90.7%)	14203 (93.5%)	4184 (82.6%)	33.9
Pre-op P2Y12 Antagonist				117.6
None	9305 (45.9%)	8716 (57.3%)	589 (11.6%)	
Clopidogrel	10010 (49.4%)	5737 (37.7%)	4273 (84.3%)	
Prasugrel	99 (0.5%)	56 (0.4%)	43 (0.8%)	
Ticagrelor	1 (0.0%)	1 (0.0%)	0 (0.0%)	
Other P2Y12 Inhibitor	238 (1.2%)	116 (0.8%)	122 (2.4%)	
No, for Medical Reason	34 (0.2%)	28 (0.2%)	6 (0.1%)	
Non-compliant	542 (2.7%)	517 (3.4%)	25 (0.5%)	
Aggrenox	32 (0.2%)	27 (0.2%)	5 (0.1%)	
Missing	3 (0.0%)	0 (0.0%)	3 (0.1%)	
Pre-op Statin	18190 (89.8%)	13627 (89.7%)	4563 (90.1%)	1.4
Pre-op ASA	18406 (90.8%)	13803 (90.8%)	4603 (90.9%)	0.1
Medication Loading				N/A
None	2957 (59.0%)	Not Applicable	2957 (59.0%)	
ASA or P2Y12 antagonist	846 (16.9%)		846 (16.9%)	
Statin	138 (2.8%)		138 (2.8%)	
Both	1072 (21.4%)		1072 (21.4%)	
Missing			53	
Pre-op Chronic Anticoagulant	2319 (11.4%)	1722 (11.3%)	597 (11.8%)	1.4
Prophylactic Anti-bradyarrhythmic	2669 (53.1%)	Not Applicable	2669 (53.1%)	N/A
Missing			39	
Pre-dilatation	965 (19.1%)	Not Applicable	965 (19.1%)	N/A
Missing			13	
Number of stents placed				N/A
1	4783 (94.4%)	Not Applicable	4783 (94.4%)	
2	283 (5.6%)		283 (5.6%)	
Missing				
Contrast Volume (mL)				N/A
Mean ± SD	31.20 ± 22.19	Not Applicable	31.20 ± 22.19	
Median (IQR)	25.00 (18.00, 40.00)		25.00 (18.00, 40.00)	
Missing			155	
Total Procedure Time				57.2
Mean ± SD	106.13 ± 66.49	117.30 ± 44.43	72.50 ± 101.40	
Median (IQR)	98.00 (73.00, 129.00)	110.00 (87.00, 139.00)	65.00 (52.00, 84.00)	
Missing	58	29	29	

Demographics and Baseline Characteristics (Patients with 1-Year Follow-Up)

0 provides a tabulation of the baseline demographics for matched CEA and TCAR patients with 1-year follow-up. For the composite endpoint analysis, there were 2,988 CEA patients and 996 TCAR patients with 1-year follow-up. Key demographic parameters were similar between the matched cohorts: symptom status, age, gender, congestive heart failure, COPD, smoking, hypertension, dialysis, kidney function, coronary artery disease and percent stenosis. Body mass index and the incidence of mild coronary artery disease were similar in patients with 1-year follow-up. The incidence of severe stenosis (>70%) was 91.5% and 91.1% for the CEA and TCAR cohorts respectively. There were differences in the procedural variables that are likely due to variations in the treatment modalities.

Table 25 Demographics and Baseline Characteristics after Matching (Patients with 1-Year Follow-Up)

	Total n = 3984	Treatment Modality		Std Diff (%)
		CEA n = 2988	TCAR n = 996	
Presenting Symptom Status				2.6
Stroke	1211 (30.4%)	904 (30.3%)	307 (30.8%)	
Cortical TIA	479 (12.0%)	360 (12.0%)	119 (11.9%)	
Retinal TIA	159 (4.0%)	117 (3.9%)	42 (4.2%)	
Unknown Stroke Severity	205 (5.1%)	152 (5.1%)	53 (5.3%)	
Asymptomatic	1930 (48.4%)	1455 (48.7%)	475 (47.7%)	
Age				1.0
Mean ± SD	70.69 ± 6.46	70.70 ± 6.37	70.64 ± 6.72	
Median (IQR)	72.00 (67.00, 76.00)	72.00 (67.00, 76.00)	72.00 (66.00, 76.00)	
Age ≥65	3307 (83.0%)	2491 (83.4%)	816 (81.9%)	3.8
Male	2629 (66.0%)	1971 (66.0%)	658 (66.1%)	0.2
Caucasian	3564 (89.5%)	2673 (89.5%)	891 (89.5%)	0.0
Race				3.6
American Indian or Alaskan Native	26 (0.7%)	18 (0.6%)	8 (0.8%)	
Asian	38 (1.0%)	28 (0.9%)	10 (1.0%)	
Black or African American	201 (5.0%)	151 (5.1%)	50 (5.0%)	
Native Hawaiian or other Pacific Islander	7 (0.2%)	5 (0.2%)	2 (0.2%)	
White	3564 (89.5%)	2673 (89.5%)	891 (89.5%)	
More than 1 race	17 (0.4%)	12 (0.4%)	5 (0.5%)	
Unknown / Other	131 (3.3%)	101 (3.4%)	30 (3.0%)	
Body Mass Index				0.3
Mean ± SD	29.01 ± 7.46	29.02 ± 5.89	28.99 ± 10.88	
Median (IQR)	28.41 (25.31, 32.26)	28.37 (25.28, 32.19)	28.73 (25.41, 32.60)	
Hispanic or Latino	183 (4.6%)	136 (4.6%)	47 (4.7%)	0.8
None vs mild CAD (i.e., without unstable angina or MI within 6 months)	1793 (45.0%)	1341 (44.9%)	452 (45.4%)	1.0
None vs. Asymptomatic/Mild CHF	503 (12.6%)	377 (12.6%)	126 (12.7%)	0.1
None vs mild COPD (i.e., not on home oxygen)	917 (23.0%)	685 (22.9%)	232 (23.3%)	0.9
Dialysis	0 (0.0%)	0 (0.0%)	0 (0.0%)	N/A

	Total	Treatment Modality		Std Diff (%)
	n = 3984	CEA n = 2988	TCAR n = 996	
ASA Class				1.8
1	14 (0.4%)	10 (0.3%)	4 (0.4%)	
2	160 (4.0%)	118 (3.9%)	42 (4.2%)	
3	2710 (68.0%)	2033 (68.0%)	677 (68.0%)	
4 or 5	1100 (27.6%)	827 (27.7%)	273 (27.4%)	
Smoking				2.3
None	922 (23.1%)	694 (23.2%)	228 (22.9%)	
Prior	2111 (53.0%)	1575 (52.7%)	536 (53.8%)	
Current	951 (23.9%)	719 (24.1%)	232 (23.3%)	
Hypertension	3611 (90.6%)	2711 (90.7%)	900 (90.4%)	1.3
Diabetes				2.1
None	2360 (59.2%)	1776 (59.4%)	584 (58.6%)	
Diet	160 (4.0%)	118 (3.9%)	42 (4.2%)	
Non Insulin	842 (21.1%)	631 (21.1%)	211 (21.2%)	
Insulin/medication dependent	622 (15.6%)	463 (15.5%)	159 (16.0%)	
Prior CABG	794 (19.9%)	591 (19.8%)	203 (20.4%)	1.5
Prior PCI	1021 (25.6%)	769 (25.7%)	252 (25.3%)	1.0
Creatinine mg/dl				1.7
Mean ± SD	1.04 ± 0.32	1.04 ± 0.33	1.04 ± 0.31	
Median (IQR)	0.99 (0.81, 1.20)	0.99 (0.81, 1.20)	0.99 (0.81, 1.20)	
GFR				1.6
Mean ± SD	74.41 ± 18.46	74.34 ± 18.53	74.63 ± 18.27	
Median (IQR)	78.12 (60.50, 88.07)	78.10 (60.50, 88.07)	78.20 (60.54, 88.18)	
GFR<60	964 (24.2%)	728 (24.4%)	236 (23.7%)	1.6
Pre-admission Living Status				2.0
Home	3938 (98.8%)	2955 (98.9%)	983 (98.7%)	
Nursing home	43 (1.1%)	31 (1.0%)	12 (1.2%)	
Homeless	3 (0.1%)	2 (0.1%)	1 (0.1%)	
Dual antiplatelet therapy	1744 (43.8%)	947 (31.7%)	797 (80.0%)	111.4
Percent Lesion Stenosis				2.8
> 50%	220 (5.5%)	163 (5.5%)	57 (5.7%)	
> 60%	121 (3.0%)	90 (3.0%)	31 (3.1%)	
> 70%	434 (10.9%)	320 (10.7%)	114 (11.4%)	
> 80%	3209 (80.5%)	2415 (80.8%)	794 (79.7%)	

Procedure Information (Patients with 1-Year Follow-Up)

0 provides a tabulation of the procedure information for matched CEA and TCAR patients with 1-year follow-up by treatment modality. The use of general anesthesia was higher in the CEA cohort. The use of pre-operative P2Y12 antagonists was higher in the TCAR patients which is expected in accordance with multi-society, treatment guidelines following CAS procedures. Mean procedure times were longer for CEA than TCAR (118.56 min vs 74.18 min respectively). The use of dual antiplatelet therapy was higher in the TCAR cohort which is expected in accordance with multi-society, treatment guidelines following CAS procedures.

Table 26 Procedure Information after Matching (Patients with 1-Year Follow-Up)

	Total	Treatment Modality		Std Diff (%)
	n = 3984	CEA n = 2988	TCAR n = 996	
Lesion Laterality				0.3
Right	1984 (49.8%)	1489 (49.8%)	495 (49.7%)	
Left	2000 (50.2%)	1499 (50.2%)	501 (50.3%)	
Lesion Length (mm)				N/A
Mean ± SD	24.96 ± 12.03	Not Reported	24.96 ± 12.03	
Median (IQR)	22.00 (17.00, 30.00)		22.00 (17.00, 30.00)	
Missing	3094		106	
General Anesthesia Use	3623 (90.9%)	2803 (93.8%)	820 (82.3%)	36.0
Pre-op P2Y12 Antagonist				123.3
None	1901 (47.7%)	1779 (59.5%)	122 (12.2%)	
Clopidogrel	1885 (47.3%)	1048 (35.1%)	837 (84.0%)	
Prasugrel	20 (0.5%)	7 (0.2%)	13 (1.3%)	
Ticagrelor	32 (0.8%)	20 (0.7%)	12 (1.2%)	
Other P2Y12 Inhibitor	8 (0.2%)	4 (0.1%)	4 (0.4%)	
No, for Medical Reason	131 (3.3%)	124 (4.1%)	7 (0.7%)	
Non-compliant	6 (0.2%)	6 (0.2%)	0 (0.0%)	
Aggrenox	1 (0.0%)	0 (0.0%)	1 (0.1%)	
Pre-op Statin	3513 (88.2%)	2629 (88.0%)	884 (88.8%)	2.4
Pre-op ASA	3583 (89.9%)	2682 (89.8%)	901 (90.5%)	2.4
Medication Loading				N/A
None	608 (61.7%)	Not Applicable	608 (61.7%)	
ASA or P2Y12 antagonist	169 (17.1%)		169 (17.1%)	
Statin	33 (3.3%)		33 (3.3%)	
Both	176 (17.8%)		176 (17.8%)	
Missing			10	
Pre-op Chronic Anticoagulant	561 (14.1%)	424 (14.2%)	137 (13.8%)	1.3
Prophylactic Anti-bradyarrhythmic	469 (47.4%)	Not Applicable	469 (47.4%)	N/A
Missing			6	
Pre-dilatation	163 (16.4%)	Not Applicable	163 (16.4%)	N/A
Missing			2	
Number of stents placed				N/A
1	949 (95.3%)	Not Applicable	949 (95.3%)	
2	47 (4.7%)		47 (4.7%)	
Missing			0	
contrast				N/A
Mean ± SD	36.19 ± 23.22	Not Applicable	36.19 ± 23.22	
Median (IQR)	30.00 (20.00, 45.00)		30.00 (20.00, 45.00)	
Missing			35	
Total Procedure Time				118.8
Mean ± SD	107.51 ± 45.65	118.56 ± 45.08	74.18 ± 27.58	
Median (IQR)	100.00 (75.00, 130.0)	111.00 (88.00, 140.00)	69.50 (55.00, 88.00)	
Missing	0))	6	
	7	1		

	Total	Treatment Modality		Std Diff (%)
	n = 3984	CEA n = 2988	TCAR n = 996	
Post-dilation (Stent 1) Missing	574 (57.9%)	Not Applicable	574 (57.9%) 4	N/A
Post-dilation (Stent 2) Missing	25 (54.3%)	Not Applicable	25 (54.3%) 950	N/A
Percent Lesion Stenosis				2.8
> 50%	220 (5.5%)	163 (5.5%)	57 (5.7%)	
> 60%	121 (3.0%)	90 (3.0%)	31 (3.1%)	
> 70%	434 (10.9%)	320 (10.7%)	114 (11.4%)	
> 80%	3209 (80.5%)	2415 (80.8%)	794 (79.7%)	

Composite Endpoint Analysis

There were two analysis populations generated to compare the propensity score matched results between CEA and TCAR to evaluate the safety and effectiveness profile of the ENROUTE Transcarotid Stent System (ENROUTE Stent) relative to CEA; all matched patients and patients with 1-year follow-up.

Results Based on All Matched Patients

All TCAR patients were treated with the ENROUTE Stent used in conjunction with the ENROUTE Transcarotid Neuroprotection System (ENROUTE NPS). The CEA and TCAR cohorts were propensity score matched (3:1 nearest neighbor, no caliper). There were no TCAR patients excluded from the matching (i.e. all standard surgical risk TCAR patients who received the ENROUTE stent from the SVS VQI were included in the analysis). The primary endpoint is a composite of death/stroke/myocardial infarction through 30 days and ipsilateral stroke from day 31 to day 365 (365 days minus 45 days).

The estimates generated for comparison of the individual outcomes between CEA and TCAR were derived using a right-censored approach for patients who did not experience the event of interest. The Kaplan-Meier (K-M) approach provides adjusted estimates based on the number of patients that remain at risk of experiencing the event. This risk-based approach is appropriate when dealing with longitudinal data where the duration of follow-up varies across patients and clinical sites. From the K-M analysis, the estimate of the rate at a specific time can be determined.

The first analysis population includes all TCAR patients (n=5,066) and three (3) matched CEA patients for every TCAR patient (n=15,198). Outcomes using Kaplan-Meier estimates are presented in 0 and 0.

Table 27 Endpoint Analysis (All Matched Patients)

Outcome	K-M Estimate for TCAR	K-M Estimate for CEA	Bootstrap 95% Confidence interval (TCAR-CEA)
30 Day Death/Stroke/MI* + 1yr Ipsilateral stroke	2.93%	2.62%	-0.38%, 1.08%
30 Day Stroke	1.40%	1.12%	
30 Day Death	0.34%	0.38%	
30 Day Death/Stroke	1.62%	1.42%	
30 Day Death/Stroke/MI*	2.00%	2.01%	
1yr Ipsilateral Stroke	1.40%	1.08%	

*MI is reported in-hospital as the CEA registry of the SVS VQI does not track MI past discharge whereas the CAS registry does.

There were no differences in the composite endpoint or components of the composite endpoint between the CEA and TCAR cohorts. To establish non-inferiority relative to the pre-specified non-inferiority margin of 5%, the upper bound of the 2-sided 95% confidence interval of the difference (TCAR minus CEA) for the composite endpoint was calculated. The results presented in 0 are drawn directly from 0 and demonstrates that the upper bound of the confidence interval of the difference for the composite endpoint is firmly below the 5% non-inferiority margin. The observed difference in the composite endpoint between the TCAR and CEA cohorts was 0.14% with an upper 95% confidence limit of 0.81% (within the pre-specified non-inferiority margin of 5%). Based on these results, TCAR using the ENROUTE Stent in conjunction the ENROUTE NPS is non-inferior to CEA in the standard surgical risk patient population.

**Figure 4 Graphical Representation of the Non-Inferiority Analysis
(All Matched Patients)**

(Difference in the Event Rates [TCAR minus CEA] from the Kaplan-Meier Estimates with the 95% Confidence Interval)

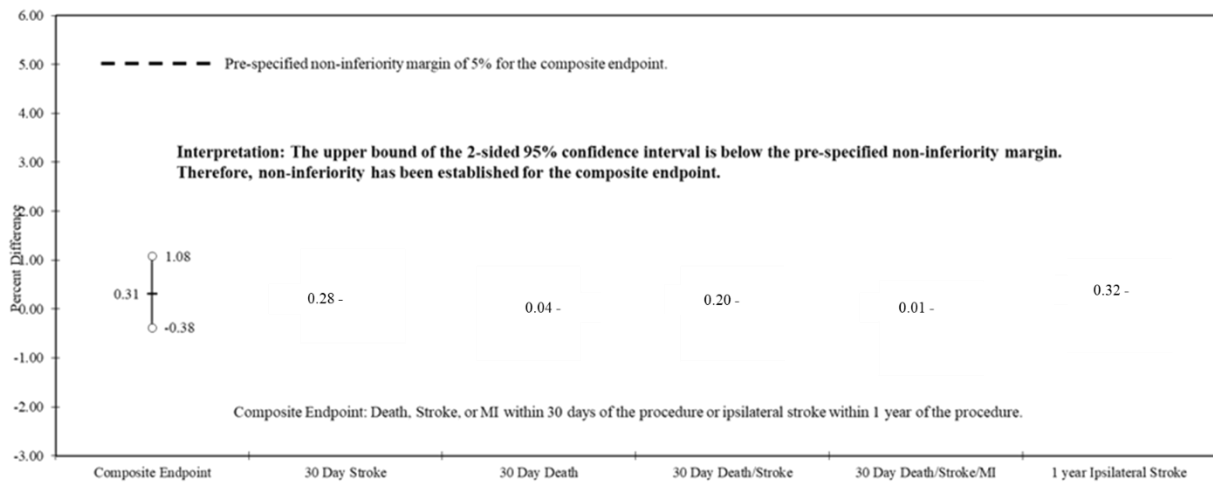

0 shows the Kaplan-Meier estimate of the freedom from the composite endpoint event for all matched patients.

Figure 5 Freedom from Composite Endpoint Event Through 1 Year (All Matched Patients)

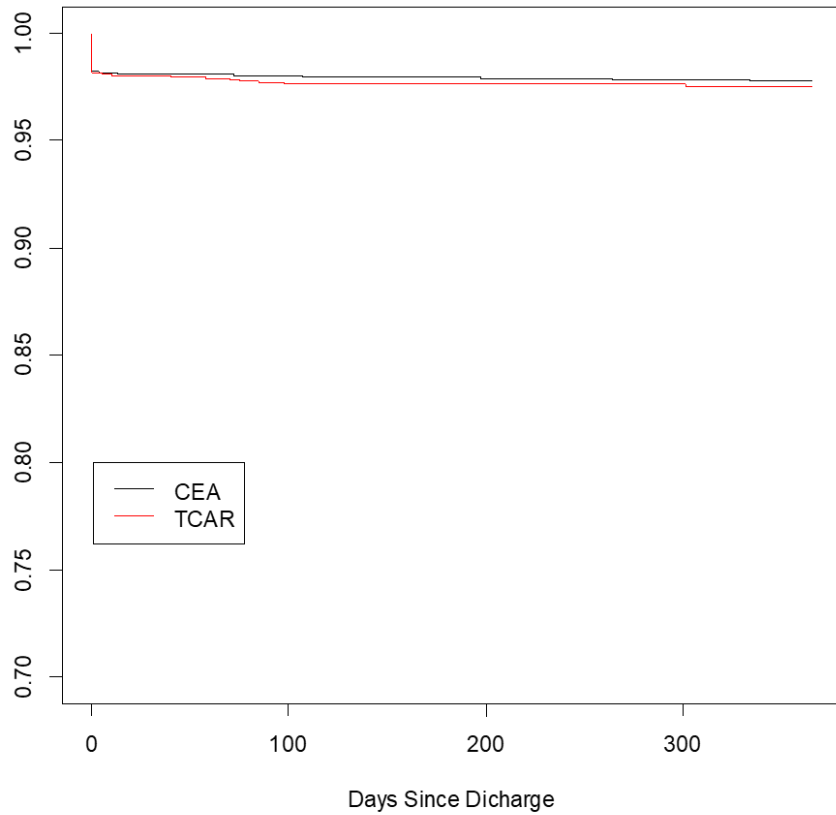

Patients with 1-Year Follow-Up

The second analysis population includes TCAR patients with 1-year follow-up (n=996) and three (3) matched CEA patients with 1-year follow-up for every TCAR patient (n=2,988).

Table 28 Endpoint Analysis (Matched Patients with 1-Year Follow-Up)

Outcome	K-M Estimate for TCAR	K-M Estimate for CEA	Bootstrap 95% Confidence interval (TCAR-CEA)
30 Day Death*/Stroke/MI** + 1yr Ipsilateral Stroke	2.31%	2.18%	-0.95%, 1.15%

*By definition, the 1-year follow-up cohort had to survive ≥320 days to be included in this analysis because a patient is only included in the 1-year cohort exclusive of a 30-day periprocedural death.

** MI is reported as in-hospital. The CEA registry of the SVS VQI does not track MI past discharge whereas the CAS registry does.

There was no difference in the 1-year endpoint between the CEA and TCAR cohorts. To establish non-inferiority relative to the pre-specified non-inferiority margin of 5%, the upper bound of the 2-sided 95% confidence interval of the difference (TCAR minus CEA) for the composite endpoint was calculated. Supplemented by an analysis of the 1-year component of the composite endpoint in CEA and TCAR patients with 1-year follow-up, TCAR using the ENROUTE Stent in conjunction the ENROUTE NPS is non-inferior to CEA in the standard surgical risk patient population.

Other Endpoint Analyses

Procedural Outcomes

0 presents other outcome and procedural measures from all matched TCAR and CEA patients. Certain procedural variables that are captured in the CAS registry of the SVS VQI are not captured in the CEA registry. Conversely, certain procedural variables that are captured in the CEA registry of the SVS VQI are not captured in the CAS registry. Those variables are presented as “Not Reported.”

Table 29 Other Outcomes and Procedural Measures (All Matched Patients)

	Total	Treatment Modality		TCAR-CEA, difference
	n = 20264	CEA n = 15198	TCAR n = 5066	
Stroke, in-hospital	226 (1.12%)	158 (1.04%)	68 (1.34%)	-0.30%
Death, in-hospital	27 (0.13%)	18 (0.12%)	9 (0.18%)	-0.06%
Myocardial Infarction (MI), in-hospital	127 (0.63%)	102 (0.67%)	25 (0.49%)	0.18%
Stroke/Death/MI, in-hospital	353 (1.74%)	260 (1.71%)	93 (1.84%)	-0.13%
Cranial Nerve Injury, in-hospital	423 (2.09%)	408 (2.68%)	15 (0.30%)	2.39%
Access Site Complication				
No	4915 (97.06%)	Not Reported	4915 (97.06%)	N/A
Yes	149 (2.94%)		149 (2.94%)	
Missing			2	
Hematoma/bleeding				
None	4930 (97.35%)	Not Reported	4930 (97.35%)	N/A
Medical Treatment	84 (1.66%)		84 (1.66%)	
Interventional Treatment	6 (0.12%)		6 (0.12%)	
Surgical Treatment	44 (0.87%)		44 (0.87%)	
Missing			2	
Postoperative stenosis/occlusion				
None	5058 (99.88%)	Not Reported	5058 (99.88%)	N/A
Medical Treatment	2 (0.04%)		2 (0.04%)	
Interventional Treatment	1 (0.02%)		1 (0.02%)	
Surgical Treatment	3 (0.06%)		3 (0.06%)	
Missing			2	
Pseudoaneurysm				
No	5062 (99.96%)	Not Reported	5062 (99.96%)	N/A
Moderate, thrombin injection	2 (0.04%)		2 (0.04%)	
Missing			2	
Return to Operating Room				
No	14916 (98.16%)	14916 (98.16%)	Not Reported	N/A
Yes, bleeding	161 (1.06%)	161 (1.06%)		
Yes, neurologic	37 (0.24%)	37 (0.24%)		
Yes, both bleeding/neurologic	3 (0.02%)	3 (0.02%)		
Yes, other CEA incision	7 (0.05%)	7 (0.05%)		
Yes, other	71 (0.47%)	71 (0.47%)		
Missing	5069	3		

As shown in 0, the incidence of in-hospital stroke, in-hospital death or in-hospital MI were similar for CEA and TCAR. The incidence of the in-hospital composite of stroke/death/MI was similar for CEA and TCAR. TCAR had a lower incidence of in-hospital cranial nerve injury than CEA (0.30% vs 2.68% respectively).

The incidence of access site complications for TCAR was 2.94%. There was no equivalent variable for CEA in the SVS VQI. The ROADSTER study supported approval of the high surgical risk indication approved in P140026. For reference, the incidence of access site complications requiring intervention in the ROADSTER study was 2.3%

(K143072). The incidence of hematoma/bleeding for TCAR was 2.70%; the incidence of those requiring interventional or surgical treatment was 0.99%. There was no equivalent variable for CEA in the SVS VQI. For reference, the incidence of wound hematoma requiring intervention in the ROADSTER study was 2.3%. The incidence of postoperative stenosis/occlusion for TCAR was 0.12%; the incidence of those requiring interventional or surgical treatment was 0.08%. There was no equivalent variable for CEA. For reference, the incidence of stenosis/occlusion in the ROADSTER study was 1.0%. The incidence of pseudoaneurysm for TCAR was 0.04%; both incidents were treated with thrombin injection. There was no equivalent variable for CEA in the SVS VQI. For reference, there were no reports of pseudoaneurysm in the ROADSTER study. For CEA, the incidence of a return to the operating room was 1.84% (bleeding/neurologic/incision/other). There was no equivalent variable for TCAR in the SVS VQI. These events are similar to those in the ROADSTER study and are expected of this device type.

9.0 Directions for Use

Only physicians who have received appropriate training for transcarotid stenting and who are familiar with the principles, clinical applications, complications, side effects and hazards commonly associated with carotid interventional procedures should use this device.

9.1 Peri-Procedural Care

**Table 30
Pre-Procedure Medications**

Medication	Dose	Time prior to procedure	Notes
Aspirin	75-325 mg*	At least 72 hrs	A 650 mg loading dose of aspirin, provided that it is not enteric coated or extended release, at least 4 hours prior to procedure is acceptable if 325 mg dosing was not administered prior to procedure or per the Institution's standard of care.
Clopidogrel	75 mg*	At least 72 hrs	A 450 mg clopidogrel loading dose at least 4 hours prior to procedure is acceptable if 75 mg dosing was not administered prior to procedure. The physician may substitute prasugrel, ticlopidine, or a generic version of clopidogrel per the manufacturer's published guidelines. If ticlopidine is prescribed, it must be administered with the appropriate safety monitoring at two weeks and at one month.

*As stated in the "2011 ASA/ACCF/AHA/AANN/AANS/ACR/ASNR/CNS/SAIP/SCAI/SIR/SNIS/SVM/SVS guideline on the management of patients with extracranial carotid and vertebral artery disease: executive summary." and "ESVS Guidelines. Invasive Treatment for Carotid Stenosis: Indications, Techniques."

**Table 31
Post-Procedure Medications**

Medication	Dose	Duration post-procedure	Notes
Aspirin	75-325 mg*	Daily, continued indefinitely	Aspirin dosage may be adjusted at the discretion of the Investigator and/or if warranted by the patient's medical condition, i.e., documented intolerance, GI bleed, etc. All change in medications are to be documented on the Concomitant Medication CRF.

Clopidogrel	75 mg*	Daily, for minimum of 4 weeks	Clopidogrel dosing may extend at physician's discretion. The physician may substitute prasugrel, ticlopidine, or a generic version of clopidogrel per the manufacturer's published guidelines.
-------------	--------	-------------------------------------	--

*As stated in the "2011 ASA/ACCF/AHA/AANN/AANS/ACR/ASNR/CNS/SAIP/SCAI/SIR/SNIS/SVM/SVS guideline on the management of patients with extracranial carotid and vertebral artery disease: executive summary." and "ESVS Guidelines. Invasive Treatment for Carotid Stenosis: Indications, Techniques."

In addition to the usual care and the suggested peri-procedure pharmacological regimen, special attention to diagnosis and management of the following conditions are critical for optimal patient care:

- Bradycardia or tachycardia
- Hypertension or hypotension
- Acute and subacute stent thrombosis
- Hyperfusion syndrome

9.2 Pre-Procedure

Refer to **Section 9.1** of these instructions for the suggested pre-procedure pharmacological treatment regimen. The placement of the stent in a stenotic or obstructed carotid artery should be done in a procedure room equipped with angiography. Angiography should be performed to map out the extent of the lesion(s) and the collateral flow. If thrombus is present, do not proceed with stent deployment. Patient preparation and sterile precautions should be the same as for any angioplasty procedure.

CAUTION: Venous access should be available during carotid stenting in order to manage bradycardia and/or hypotension either by pharmaceutical intervention or placement of a temporary pacemaker if needed.

CAUTION: When catheters are in the body, they should be manipulated only under fluoroscopy. Radiographic equipment that provides high quality images is needed.

a. **Inject contrast media** – Perform an angiogram using the technique described in the ENROUTE Transcarotid NPS's Instructions for Use.

b. **Identify and mark the lesion** – Fluoroscopically identify and mark the lesion, observing the most distal level of the stenosis.

9.3 Device Selection and Preparation

1. Select Stent Size

Measure the length of the target lesion to determine the length of stent(s) required. When more than one stent is required to cover the lesion, the more distal stent should be placed first. Overlap of sequential stents is necessary, but the amount of overlap should be kept to a minimum (approximately 5 mm).

Measure the diameter of the reference vessel (proximal and distal to the lesion). It is necessary to select a stent, which has an unconstrained diameter that is 1 to 2 mm larger than the largest reference vessel diameter to achieve secure placement according to the following Stent Size Selection Table (**Table 32**).

Table 32
ENROUTE Transcarotid Stent System - Stent Size Selection Table

Vessel Lumen Diameter (mm)	Unconstrained Stent Diameter (mm)	% Length Foreshortening* (%)
3.0 – 4.0	5.0	1.2
4.0 – 5.0	6.0	2.4
5.0 – 6.0	7.0	4.1
6.0 – 7.0	8.0	6.2
7.0 – 8.0	9.0	5.8

8.0 – 9.0	10.0	8.0
-----------	------	-----

*Calculated

2. Preparation of Stent Delivery System

CAUTION: The ENROUTE Transcarotid Stent System is supplied **STERILE** and is intended for single use only. **DO NOT** resterilize and/or reuse the device. Assure that the device had been properly stored in a cool, dark, dry place prior to use.

CAUTION: Use the ENROUTE Transcarotid Stent System prior to the “Use By” date specified on the package. Do not use if the pouch is opened or damaged.

CAUTION: The ENROUTE Transcarotid Stent System is shipped with the Tuohy Borst valve **OPEN**. Be careful not to prematurely deploy the stent during preparation. The system should be prepped in the sterile tray per the below instructions. Close the Tuohy Borst valve prior to removing the device from the tray.

- a. Open the outer box to reveal the pouch containing the stent and delivery system.
- b. Check the temperature exposure indicator on the pouch to confirm that the black dotted pattern with a gray background is clearly visible. Do not use if entire temperature exposure indicator is completely black as the unconstrained stent diameter may have been compromised.
- c. After careful inspection of the pouch looking for damage to the sterile barrier, carefully peel the pouch open and remove the tray. Without removing the device from the tray, examine the device for any damage. If it is suspected that the sterility or performance of the device has been compromised, the device should not be used.
- d. With the device in the tray, attach a stopcock to the Y connection on the Tuohy Borst valve.
- e. (Refer to Fig. 2) With the device still in the tray, attach a 5-cc syringe filled with heparinized saline solution to the opened stopcock attached to the Y connection (9) on the Tuohy Borst valve (1). Ensure that the Tuohy Borst proximal end valve (12) is in the open position. Apply positive pressure to the syringe until saline weeps from the proximal end of the Tuohy Borst valve (12). Lock the Tuohy Borst valve.
- f. Close the stopcock attached to the Tuohy Borst Y connection.
- g. Extract the stent delivery system from the tray. Examine the device for any damage. Evaluate the distal end of the catheter to ensure that the stent is contained within the outer sheath. Do not use if the stent is partially deployed. If a gap between the catheter tip and outer sheath tip exists, open the Tuohy Borst valve and gently pull the inner shaft in a proximal direction until the gap is closed. Lock the Tuohy Borst valve after the adjustment by rotating the proximal valve end in a clockwise direction.

9.4 Stent Deployment Procedure

WARNING: Ensure that the catheter system is flushed according to the steps outlined in "Introduction of Stent Delivery System". Failure to do so could result in air entering the ENROUTE Transcarotid Arterial Sheath.

WARNING: Ensure that there is a tight seal between the ENROUTE Transcarotid Stent System and the valve for the ENROUTE Transcarotid Arterial Sheath during aspiration. Failure to do so could result in air entering the ENROUTE Transcarotid Arterial Sheath.

WARNING: Do not use with Ethiodol or Lipiodol* contrast media, which may adversely affect the stent delivery system.

*Ethiodol and Lipiodol are Trademarks of Gerbert S.A.

WARNING: Do not expose the delivery system to organic solvents (e.g., alcohol), as structural integrity and/or function of the device may be impaired.

CAUTION: The delivery system is not designed for the use of power injection. Use of power injection may adversely affect device performance.

1. Insertion of ENROUTE Transcarotid Neuroprotection System

- a. Access the treatment site utilizing the ENROUTE Transcarotid NPS in accordance with the Instructions for Use.
- b. The ENROUTE Transcarotid Stent System is compatible with a .014" (0.36 mm) or smaller guidewire.

2. Dilation of Lesion

- a. If appropriate, pre-dilate the lesion using standard PTA techniques.
- b. Remove the PTA balloon catheter from the patient maintaining lesion access with the guidewire.

3. Introduction of Stent Delivery System

**Figure. 6 ENROUTE Transcarotid Stent System Description
(Refer to Fig. 1 for component list)**

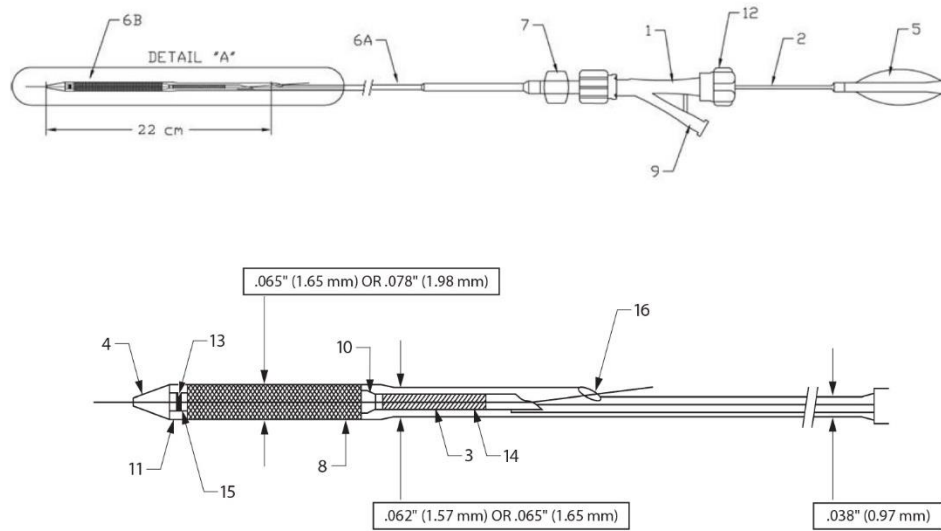

a. Flush the guidewire lumen of the stent delivery system with heparinized saline by connecting a 5-cc syringe filled with heparinized saline solution to the stopcock attached to the Y connection (9) on the Tuohy Borst valve (1) to expel air. Ensure that the Tuohy Borst proximal end valve (12) is in the locked position to prevent premature stent deployment. Apply positive pressure to the syringe until saline weeps from the guidewire exit port (16). While covering the guidewire exit port (16) with thumb and forefinger, apply positive pressure to the syringe until saline weeps from the catheter tip (4) and the space between the outer sheath radiopaque marker (11) and the catheter tip (4). Continue to flush to ensure all air is removed from the system, then close the stopcock attached to the Y connection (9) on the Tuohy Borst valve.

b. Ensure the Tuohy Borst valve (1) connecting the inner shaft and outer sheath is locked by rotating the proximal valve end (12) in a clockwise direction to prevent premature stent deployment.

c. Advance the ENROUTE Transcarotid Stent System over the .014" (0.36 mm) guidewire until the guidewire exit port (16) is just outside the ENROUTE Transcarotid Arterial Sheath valve. Look for and confirm back flow through the guidewire exit port (16) opening.

d. After confirming back flow, advance the ENROUTE Transcarotid Stent System to the lesion site.

e. Perform contrast injections in accordance to ENROUTE Transcarotid NPS Instructions for Use.

CAUTION: If resistance is met during delivery system introduction, the system should be withdrawn and another system should be used, while the ENROUTE Transcarotid NPS remains in place.

4. Slack Removal

a. Advance the stent delivery system past the lesion site.

b. Pull back the stent delivery system until the radiopaque inner shaft markers (leading and trailing ends) move in position so that they are proximal and distal to the target lesion.

c. Ensure the stent delivery system outside the patient remains flat and straight.

CAUTION: Prior to stent deployment, remove all slack from the catheter delivery system. Slack in the catheter shaft either outside or inside the patient may result in deployment of the stent beyond the lesion site.

5. Stent Deployment

WARNING: The stent is not designed for dragging or repositioning. Once the stent is partially deployed, it cannot be recaptured using the stent delivery system. The mechanism for stent deployment is outer sheath retraction. Deployment is completed by maintaining inner shaft position while retracting the outer sheath and allowing the stent to expand. **NOTE:** It is recommended that heparin (intravenous) be given during the procedure before the

ENROUTE Transcarotid NPS is placed. The initial bolus doses of heparin should be approximately 3,000 to 5,000 units (with necessary weight adjustments). Additional bolus doses of heparin should be given to maintain an ACT near 250 seconds during the entire procedure. No heparin should be given after the procedure until hemostasis at the puncture site is achieved.

- a. Verify that the delivery system's radiopaque inner shaft markers (leading and trailing ends) are proximal and distal to the target lesion.
- b. Verify that the delivery system's radiopaque inner shaft marker (trailing end) is distal to the radiopaque marker at the tip of the ENROUTE Transcarotid Arterial Sheath.
- c. Unlock the Tuohy Borst proximal valve end connecting the inner shaft and outer sheath of the delivery system.
- d. Ensure that the ENROUTE Transcarotid Arterial Sheath does not move during deployment.
- e. Initiate stent deployment by retracting the outer sheath while holding the inner shaft in a fixed position. Deployment is complete when the outer sheath marker passes the proximal inner shaft stent marker.

CAUTION: When more than one stent is required to cover the lesion, or if there are multiple lesions, the more distal stent should be placed first. Stenting in this order obviates the need to cross the proximal stent in placement of the distal stent and reduces the chance for dislodging stents that have already been placed.

CAUTION: Overlap of sequential stents is necessary but the amount of overlap should be kept to a minimum (approximately 5 mm). In no instance, should more than two (2) stents ever overlap.

6. Post-Deployment Stent Dilatation

WARNING: Long-term outcomes following repeat dilatation of endothelialized stents are unknown.

CAUTION: The delivery system is not designed for the use of power injection. Use of power injection may adversely affect device performance.

CAUTION: Re-crossing a deployed stent with adjunct devices must be performed with caution.

a. While using fluoroscopy, withdraw the entire delivery system as one unit, over the guidewire and out of the body. Remove the delivery device from the guidewire.

NOTE: If any resistance is met during delivery system withdrawal, advance the outer sheath until the outer sheath marker contacts the catheter tip and withdraw the system as one unit. (Do not remove guidewire.)

b. Using fluoroscopy, visualize the stent to verify full deployment.

c. If incomplete expansion exists within the stent at any point along the lesion, post-deployment balloon dilatation (standard PTA technique) can be performed.

d. Select an appropriate size PTA balloon dilatation catheter and dilate the lesion with conventional technique. The inflation diameter of the PTA balloon dilatation catheter used for post-dilatation should not exceed the diameter of the reference vessel.

e. Remove the PTA balloon from the patient.

7. Post Stent Placement

a. A post-stent angiogram can be obtained per institutional protocol.

b. Remove the ENROUTE Transcarotid NPS in accordance with that device's Instructions for Use.

c. Follow the suggested post-procedure pharmacological treatment regimen described in **Section 9.1** of these instructions.

WARNING: In the event of thrombosis of the expanded stent, thrombolysis and PTA should be attempted.

WARNING: In the event of complications such as infection, pseudoaneurysm or fistulization, surgical removal of the stent may be required.

8. Patient Information

In addition to these Instructions for Use, the ENROUTE Transcarotid Stent System is packaged with a Stent Implant Card for the patient that contains specific information about the ENROUTE Transcarotid Stent System. All patients should be instructed to keep this card in their possession at all times for procedure/stent identification.

9. How Supplied

ENROUTE Transcarotid Stent System is supplied sterile by ethylene oxide gas and is intended for SINGLE USE ONLY. It has not been validated for resterilization or reuse. Silk Road Medical shall not be responsible for any damages, including without limitation direct, incidental or consequential damages, resulting from reuse or resterilization of this product.

10.0 LICENSE AND PATENT DISCLOSURE

This product is being made, sold and distributed pursuant to a license from Cordis Corporation.



Silk Road Medical, Inc.
Sunnyvale, CA 94089
USA

Phone: +1 (408) 720-9002 Fax: +1 (408) 720-9013
www.silkroadmed.com



RECYCLED CONTENT

ENROUTE and the Silk Road Medical logo are registered trademarks of Silk Road Medical.

Information concerning patents and trademarks for Silk Road products and procedures can be found at www.silkroadmed.com/patents.